

Product Portfolio

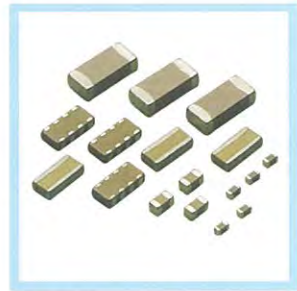

Multilayer Ceramic Capacitors (MLCC)



Chip-Resistor



Disc Capacitors



RF Device and High Frequency Inductors

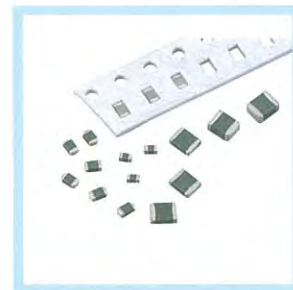

Varistors and SMD-Varistors

IEC-63 Nominal Resistance / Capacitance

E1	100																							
E3	100			220			470																	
E6	100	150	220	330	470	680																		
E12	100	120	150	180	220	270	330	390	470	560	680	820												
E24	100	110	120	130	150	160	180	200	220	240	270	300	330	360	390	430	470	510	560	620	680	750	820	910
E96	100	102	121	124	147	150	178	182	215	221	261	267	316	324	383	392	464	475	562	576	681	698	825	845
	105	107	127	130	154	158	187	191	226	232	274	280	332	340	402	412	487	499	590	604	715	732	866	887
	110	113	133	137	162	165	196	200	237	243	287	294	348	357	422	432	511	523	619	634	750	768	909	931
	115	118	140	143	169	174	205	210	249	255	301	309	365	374	442	453	536	549	649	665	787	806	953	976

E6:  $\sqrt[6]{10} \approx 1.46$  E12:  $\sqrt[12]{10} \approx 1.21$   
E1 series resistance: 1Ω, 10Ω, 100Ω, 1000Ω, 10000Ω, 100000Ω

INDEX

Subject	Page
Quick Product Information .....	1
How To Order and Packaging Dimension/Quantity .....	2
The Outlines and External Dimensions of Capacitors .....	3
General Purpose Caps (6.3V~100V) .....	4
Ultra-small Caps (01R5 series) .....	9
Middle & High Voltage Caps (200V~3kV) .....	10
High Q & Low ESR Caps (HH series) .....	13
Microwave Caps (RF series) .....	15
Soft Termination Capacitors (SH/SG series) .....	17
Open-mode Design Caps (OP series) .....	23
Capacitor Arrays (Y4C2/Y4C3 series) .....	25
Low Profile Caps (TT series) .....	26
Low Inductance Caps (0612 series) .....	27
Safety Certificated Caps X1/Y2 (S2 series) .....	28
Safety Certificated Caps X2/Y3 (S3 series) .....	29
Automotive Capacitor Qualified to AEC-Q200 (MT series) .....	30
Automotive Caps Without AEC-Q200 Certification (MG series) .....	31
Automotive Capacitor Arrays Qualified to AEC-Q200 (MY series) .....	34
Appendix   : Reliability Test Conditions and Requirements .....	35
Appendix    : General Information .....	38

\*The specifications are subject to change or our products in it may be discontinued without advance notice. Please check with our sales representatives or product engineers before ordering.  
\*This catalog has only typical specifications because there is no space for detailed specifications. Therefore, please approve our product specifications or transact the approval sheet for product specifications before ordering.



QUICK PRODUCT INFORMATION

Series	Dielectric	Size	Capacitance	Rated voltage	Page
General Purpose Caps (6.3V~100V)	NPO	0201, 0402, 0603, 0805, 1206, 1210, 1812	0.3pF~0.1μF	10V, 16V, 25V, 50V, 100V	5
	X7R	0201, 0402, 0603, 0805, 1206, 1210, 1812	100pF~47μF	6.3V, 10V, 16V, 25V, 50V, 100V	
	X6S	0402, 0603, 0805, 1206, 1210	0.47μF~100μF	6.3V, 10V, 16V, 25V	
	X5R	0201, 0402, 0603, 0805, 1206, 1210	0.027μF~100μF	6.3V, 10V, 16V, 25V, 50V	
	Y5V	0402, 0603, 0805, 1206, 1210, 1812	0.01μF~100μF	6.3V, 10V, 16V, 25V, 50V, 100V	
Ultra-small Caps (01R5 series)	NPO	01005	0.2pF~100pF	16V	9
	X7R	01005	100pF~1000pF	10V	
	X5R	01005	1000pF~0.1μF	6.3V, 10V	
Middle & High Voltage Caps (200V~3kV)	NPO	0603, 0805, 1206, 1210, 1808, 1812	0.5pF~6800pF	200V, 250V, 500V, 630V, 1kV, 2kV, 3kV	11
	X7R	0603, 0805, 1206, 1210, 1808, 1812	100pF~1μF	200V, 250V, 500V, 630V, 1kV, 2kV, 3kV	
	Y5V	0805, 1206, 1210, 1812	0.01μF~0.68μF	200V, 250V	
High Q & Low ESR Caps (HH series)	NPO	0402, 0603, 0805	0.1pF~3300pF	16V, 25V, 50V, 100V, 200V, 250V, 500V, 630V	14
Microwave Caps (RF series)	NPO	0201, 0402, 0603, 0805	0.1pF~100pF	6.3V, 10V, 25V, 50V, 100V, 500V	16
Soft Termination Capacitors (SH/ SG series)	NPO	0402, 0603, 1206, 1210, 1808	0.5pF~0.015μF	10V, 16V, 25V, 50V, 100V, 200V, 250V, 500V, 630V, 1kV, 3kV	18
	X7R	0402, 0603, 0805, 1206, 1210, 1808, 1812	100pF~10μF	10V, 16V, 25V, 50V, 100V, 200V, 250V, 500V, 630V, 1kV, 2kV, 3kV	
Open-mode Design Caps (OP series)	X7R	0805, 1206, 1210, 1812	100pF~1μF	100V, 200V, 250V, 500V	23
Capacitor Arrays (Y4C2/Y4C3 series)	NPO	0508 (4x0402), 0612 (4x0603)	10pF~470pF	25V, 50V, 100V	25
	X7R	0508 (4x0402), 0612 (4x0603)	180pF~0.1μF	10V, 16V, 25V, 50V	
	Y5V	0612 (4x0603)	0.01μF~0.1μF	16V, 50V	
Low Profile Caps (TT series)	X7R	0805, 1206	0.22μF~4.7μF	10V, 16V, 25V, 50V	26
	X5R	0603, 0805, 1206, 1210	0.22μF~22μF	6.3V, 10V, 16V, 25V, 50V	
	Y5V	0805, 1206, 1210	1μF~10μF	10V, 16V, 25V, 50V	
Low Inductance Caps (0612 series)	X7R	0612	0.01μF~0.15μF	50V	27
Safety Certificated Caps X1/Y2 (S2 series)	NPO	1808, 1812, 2211	4pF~680pF	250Vac	28
	X7R	1808, 1812, 2220, 2211	100pF~4700pF	250Vac	
Safety Certificated Caps X2/Y3 (S3 series)	NPO	1808, 1812	3.9pF~1000pF	250Vac	29
	X7R	1808, 1812	150pF~5600pF	250Vac	
Automotive Capacitor Qualified to AEC-Q200 (MT series)	NPO	0402, 0603, 0805, 1206, 1210	0.5pF~0.01μF	10V, 16V, 25V, 50V, 100V, 250V, 500V, 630V	30
	X7R	0402, 0603, 0805, 1206, 1210	100pF~1μF	10V, 16V, 25V, 50V, 100V	
Automotive Caps Without AEC-Q200 Certification (MG series)	NPO	0402, 0603, 0805, 1206, 1210, 1812	0.5pF~0.033μF	10V, 16V, 25V, 50V, 100V, 200V, 250V	31
	X7R	0402, 0603, 0805, 1206, 1210, 1812	100pF~2.2μF	10V, 16V, 25V, 50V, 100V, 200V, 250V	
	X5R	0402, 0603, 0805, 1206, 1210	0.056μF~10μF	6.3V, 10V, 16V, 25V	
Automotive Capacitor Arrays Qualified AEC-Q200 (MY Series)	NPO	0508 (4x0402)	10pF~220pF	50V	34
	X7R	0508 (4x0402)	1000pF~0.1μF	10V, 16V, 25V	

HOW TO ORDER

Type of MLCC	0805	B	104	K	500	C	T
General Purpose MLCC	Inch (mm) : 0201 (0603), 0603 (1608), 1206 (3216), 1808 (4520),	Dielectric	Capacitance	Tolerance	Rated voltage	Termination	Packaging
Middle & High Voltage MLCC	Size 01R5 (0402), 0402 (1005), 0805 (2012), 1210 (3225), 1812 (4532)	N=NPO, B=X7R, S=X6S, X=X5R, F=Y5V	Two significant digits followed by no. of zeros. And R is in place of decimal point.	A= ±0.05pF, B= ±0.1pF, C= ±0.25pF, D= ±0.5pF, F= ±1%, G= ±2%, J= ±5%, K= ±10%, M= ±20%, Z= -20/+80%	Two significant digits followed by no. of zeros. And R is in place of decimal point.	L=Ag/Ni/Sn, C=Cu/Ni/Sn	B=Bulk, C=Bulk cassette, T=7" reeled, Q=10" reeled, G=13" reeled
Ultra-small MLCC	0612 (1632)						
Low Inductance MLCC	RF Series						
High Q / Low ESR MLCC	Series HH=High Q/ Low ESR, RF=Microwave, TT=Low profile, OP=Open-mode design, S2=X1/Y2 safety class, S3=X2/Y3 safety class, LD= Low distortion, MG=Automotive Cap. without AEC-Q200, MT=Automotive Cap. with AEC-Q200, MY=Automotive Array with AEC-Q200		03 Size				
Microwave MLCC	Inch : 02=01005, 03=0201, 15=0402, 11=0505, 18=0603, 21=0805, 12=0508, 31=1206, 32=1210, 42=1808, 43=1812, 52=2211, 55=2220						
Low Profile MLCC							
Open Mode MLCC							
Safety Certificated MLCC							
Low Distortion MLCC							
Automotive MLCC							
Soft Termination MLCC	SH=With Ag polymer, SG=With Cu polymer						
Cap Arrays MLCC	Y=Capacitor array, 4C=4xCap		3 Termination pitch, 3=0.03 inch, 2=0.02 inch				

\* The packaging code per each size of reel, please refer to following table "packaging style and quantity".

PACKAGING STYLE AND QUANTITY

Size	Thickness (mm)/Symbol	Paper tape		Plastic tape		
		7" reel	13" reel	7" reel	13" reel	
01005 (0402)	0.20±0.02	V	20,000	-	-	
0201 (0603)	0.30±0.03	L	15,000	70,000	-	
0402 (1005)	0.50±0.05	N	10,000	50,000	-	
	0.50+0.02/-0.05	Q	10,000	50,000	-	
	0.50±0.20	E	10,000	-	-	
0603 (1608)	0.50±0.10	H	4,000	-	-	
	0.80±0.07	S	4,000	15,000	-	
	0.80+0.15/-0.10	X	4,000	15,000	-	
0805 (2012)	0.50±0.10	H	4,000	15,000	-	
	0.60±0.10	A	4,000	15,000	-	
	0.80±0.10	B	4,000	15,000	-	
	0.85±0.10	T	4,000	15,000	-	
	1.25±0.10	D	-	-	3,000	10,000
	1.25±0.20	I	-	-	3,000	10,000
1206 (3216)	0.80±0.10	B	4,000	15,000	-	
	0.85±0.10	T	4,000	15,000	-	
	0.95±0.10	C	-	-	3,000	10,000
	1.15±0.15	J	-	-	3,000	10,000
	1.25±0.10	D	-	-	3,000	10,000
	1.60±0.20	G	-	-	2,000	10,000
1210 (3225)	1.60+0.30/-0.10	P	-	-	2,000	9,000
	0.85±0.10	T	-	-	3,000	10,000
	0.95±0.10	C	-	-	3,000	10,000
	1.25±0.10	D	-	-	3,000	10,000
	1.60±0.20	G	-	-	2,000	-
	2.00±0.20	K	-	-	1,000	6,000
1808 (4520)	2.50±0.30	M	-	-	1,000	6,000
	1.25±0.10	D	-	-	2,000	10,000
	1.10±0.15	F	-	-	2,000	10,000
	1.60±0.20	G	-	-	2,000	8,000
1812 (4532)	2.00±0.20	K	-	-	1,000	6,000
	2.50±0.30	M	-	-	1,000	5,000
	2.80±0.30	U	-	-	500	3,000
	1.25±0.10	D	-	-	1,000	-
	1.60±0.20	G	-	-	1,000	-



## ■ SINGLE CHIP CAPACITORS

Outline	Size Inch (mm)	L (mm)	W (mm)	T (mm)/Symbol	Soldering Method *	M <sub>B</sub> (mm)
01R5 (0402)	0.40±0.02 0.6±0.03	0.20±0.02 0.3±0.03	0.20±0.02 0.3±0.03	V	R	0.10±0.03
				L	R	0.15±0.05
0201 (0603)	0.6±0.05 <sup>#2</sup> 0.6±0.09 <sup>#3</sup>	0.3±0.05 <sup>#2</sup> 0.3±0.09 <sup>#3</sup>	0.3±0.05 <sup>#2</sup> 0.3±0.09 <sup>#3</sup>	N	R	0.15±0.05
				Q	R	0.15±0.1/-0.05
0402 (1005)	1.00±0.05 1.00±0.20	0.50±0.05 0.50±0.20	0.50±0.05 0.50±0.20	E	R	0.25±0.05/-0.10
				S	R / W	
0603 (1608)	1.60±0.15/-0.10 1.60±0.20 <sup>#1</sup>	0.80±0.15/-0.10 0.80±0.20 <sup>#1</sup>	0.50±0.10 0.80±0.15/-0.10 0.80±0.20 <sup>#1</sup>	H	R / W	0.40±0.15
				X	R / W	
0805 (2012)	2.00±0.15 2.00±0.20	1.25±0.10 1.25±0.20	0.50±0.10 0.60±0.10 0.80±0.10 1.25±0.10	H	R / W	0.50±0.20
				A	R / W	
				B	R / W	
				D	R	
1206 (3216)	3.20±0.15 3.20±0.20	1.60±0.15 1.60±0.20	0.80±0.10 0.95±0.10 1.25±0.10 1.15±0.15	B	R / W	0.60±0.20 (0.5±0.25) <sup>***</sup>
				C	R	
				D	R	
	J	R				
	G	R				
	T	R / W				
1210 (3225)	3.20±0.30 3.20±0.40	2.50±0.20 2.50±0.30	0.85±0.10 1.25±0.10 1.60±0.20 2.00±0.20 2.50±0.30	C	R	0.75±0.25
				T	R	
				D	R	
				K	R	
1808 (4520)	4.50±0.40 (4.5±0.5/-0.3) <sup>**</sup>	2.03±0.25	1.25±0.10 1.40±0.15 1.60±0.20 2.00±0.20	D	R	0.75±0.25 (0.5±0.25) <sup>***</sup>
				F	R	
				G	R	
				K	R	
1812 (4532)	4.50±0.40 (4.5±0.5/-0.3) <sup>**</sup>	3.20±0.30 3.20±0.40	1.25±0.10 1.60±0.20 2.00±0.20 2.50±0.30 2.80±0.30	D	R	0.75±0.25 (0.5±0.25) <sup>***</sup>
				G	R	
				K	R	
				M	R	
U	R					

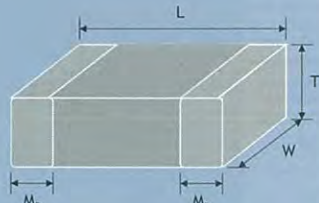

\* R = Reflow soldering process ; W = Wave soldering process.  
 \*\* For 1808\_200~3kV, 1812\_200V~3kV and safety certificated products.  
 \*\*\* For 1206\_1000V ~3kV, 1808\_200~3kV, 1812\_200~3kV and safety certificated products.  
 #1 : For 0603/X5R/X6S/6.3V/Cap≥10μF products.  
 #2 : For 0201/Cap≥0.68μF products. #3 : For 0201/Cap >1μF products.  
 Soft termination product please refer to individual sheet for detail.

## ■ Capacitor Arrays

Outline	Size Inch (mm)	L (mm)	W (mm)	T (mm)/Symbol	S (mm)	BW (mm)	P (mm)
0603 x 4 (0612 (1632))	0603 x 4 (0612 (1632))	3.20±0.15	1.60±0.15	0.80±0.10	B	0.30±0.20	0.40±0.15
					0.80±0.15		
0402 x 4 (0508 (1220))	0402 x 4 (0508 (1220))	2.00±0.15	1.25±0.15	0.85±0.10	T	0.20±0.10	0.25±0.10
						0.25±0.10	0.50±0.10

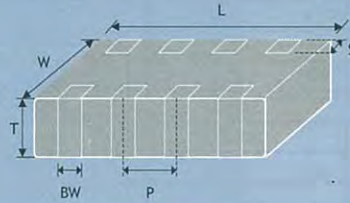

Reflow soldering process only.

## ■ Low Inductance Capacitors / RF series

Outline	Size Inch (mm)	L (mm)	W (mm)	T (mm)/Symbol	T <sub>a</sub> min. (mm)	T <sub>b</sub> min. (mm)
0612 (1632)	0612 (1632)	3.20±0.15	1.60±0.15	0.80±0.10	B	0.5
					0.13	
0508 (1220)	0508 (1220)	2.00±0.15	1.25±0.15	0.85±0.10	T	0.38
						0.13

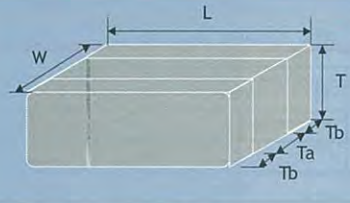

Reflow soldering process only.

## ■ FEATURES

- \* A wide selection of sizes is available (0201 to 1812).
- \* High capacitance in given case size.
- \* Capacitor with lead-free termination (pure Tin).

## ■ GENERAL ELECTRICAL DATA

Dielectric	NPO	X7R	X6S	X5R	Y5V
Size	0201, 0402, 0603, 0805, 1206, 1210, 1812				
Capacitance range	0.1pF to 0.1μF	100pF to 47μF	0.1μF to 100μF	100pF to 220μF	0.01μF to 100μF
Capacitance tolerance	Cap≤5pF <sup>#1</sup> : A (±0.05pF), B (±0.1pF), C (±0.25pF) 5pF<Cap<10pF: C (±0.25pF), D (±0.5pF) Cap≥10pF: F(±1%), G (±2%), J (±5%),K (±10%)	J (±5%), K (±10%), M (±20%)	K (±10%), M (±20%)	K (±10%), M (±20%)	M (±20%), Z (-20/+80%)
Rated voltage (WVDC)	10V, 16V, 25V, 50V, 100V	6.3V, 10V, 16V, 25V, 50V, 100V			
Operating temperature	-55 to +125°C		-55 to +105°C	-55 to +85°C	-25 to +85°C
Capacitance characteristic	±30ppm	±15%	±22%	±15%	+30/-80%
Termination	Ni/Sn (lead-free termination)				

#1: NPO, 0.1pF product only provide B tolerance

## ■ EXPLANATION OF PART NUMBERS

1206	F	104	Z	500	C	T
Size (Inch (mm)) 1206 (3216)	Dielectric F=Y5V	Capacitance 104=10x10 <sup>4</sup> =100nF	Tolerance Z=-20/+80%	Rated voltage 500=50 VDC	Termination C=Cu/Ni/Sn	Packaging style T=7" reeled

Please refer to page 2 "How to order" for more information.

## ■ ELECTRICAL CHARACTERISTICS

### 1) Frequency characteristics

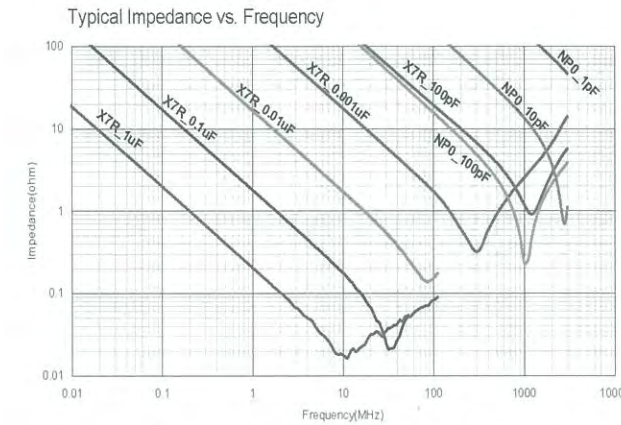

### 2) Capacitance Change - Typical aging rate

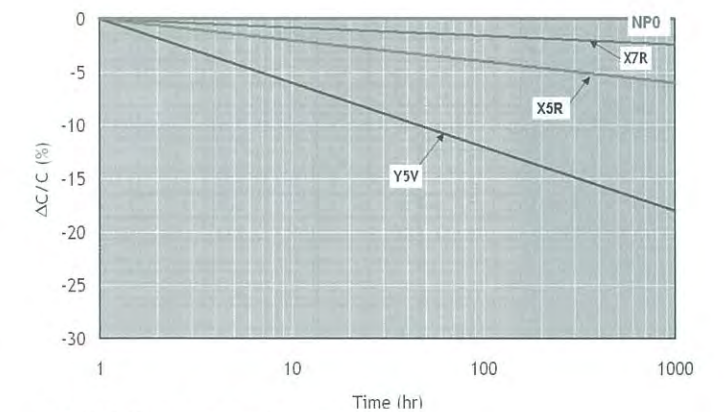

### 3) Temperature characteristics of capacitance (TCC)

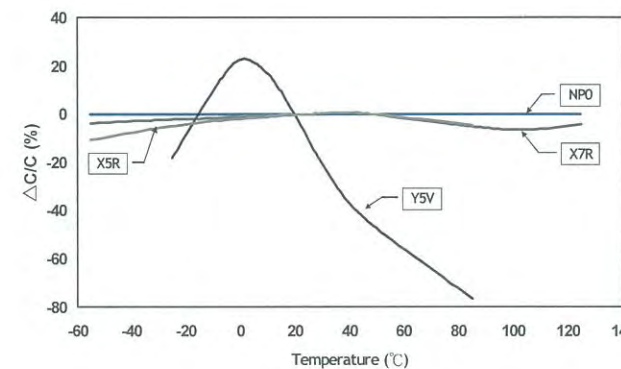

### 4) DC Bias characteristics

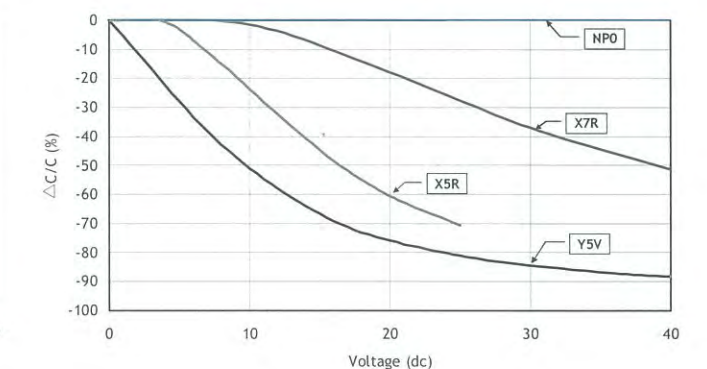

All above typical electronic characteristics are for reference only.  
 Please contact with Walsin representative for detail information of any specific item.











### FEATURES

- \* High capacitance in unit size.
- \* High precision dimensional tolerances.
- \* Suitable used in high-accuracy automatic mounting machine.

### GENERAL ELECTRICAL DATA

Size	01R5		
Dielectric	NPO	X7R	X5R
Capacitance*	0.2pF to 100pF	100pF & 1000pF	1000pF to 0.1μF
Capacitance tolerance**	Cap≤10pF: C (±0.25pF) Cap>10pF: J (±5%) K (±10%), M (±20%)		
Rated voltage (WVDC)	16V	10V	6.3V, 10V
Operating temperature	-55 to +125°C	-55 to +125°C	-55 to +85°C
Capacitance change	±30ppm ±15%		
Termination	Ni/Sn (lead-free termination)		

### EXPLANATION OF PART NUMBERS

01R5	N	100	J	160	C	T
Size (Inch (mm))	Dielectric	Capacitance	Tolerance	Rated voltage	Termination	Packaging style
01R5=01005 (0402)	N=NPO(C0G)	100=10x10 <sup>0</sup> =10pF	J=±5%	160=16 VDC	C=Cu/Ni/Sn	T=7" reeled

Please refer to page 2 "How to order" for more information.

### CAPACITANCE RANGE

SIZE	01R5
DIELECTRIC	NPO
RATED VOLTAGE (VDC)	16
0.2pF (0R2)	V
0.3pF (0R3)	V
0.4pF (0R4)	V
0.5pF (0R5)	V
1.0pF (1R0)	V
1.5pF (1R5)	V
2.0pF (2R0)	V
3.0pF (3R0)	V
4.0pF (4R0)	V
5.0pF (5R0)	V
6.0pF (6R0)	V
7.0pF (7R0)	V
8.0pF (8R0)	V
9.0pF (9R0)	V
10pF (100)	V
12pF (120)	V
15pF (150)	V
18pF (180)	V
22pF (220)	V
27pF (270)	V
33pF (330)	V
39pF (390)	V
47pF (470)	V
56pF (560)	V
68pF (680)	V
82pF (820)	V
100pF (101)	V

SIZE	01R5
DIELECTRIC	X7R
RATED VOLTAGE (VDC)	10
100pF (101)	V
120pF (121)	V
150pF (151)	V
180pF (181)	V
220pF (221)	V
270pF (271)	V
330pF (331)	V
390pF (391)	V
470pF (471)	V
560pF (561)	V
680pF (681)	V
820pF (821)	V
1,000pF (102)	V

SIZE	01R5	
DIELECTRIC	X5R	
RATED VOLTAGE (VDC)	6.3	10
1,000pF (102)	V	V
1,500pF (152)	V	V
2,200pF (222)	V	V
3,300pF (332)	V	V
4,700pF (472)	V	V
6,800pF (682)	V	V
0.010μF (103)	V	V
0.015μF (153)	V	V
0.022μF (223)	V	V
0.033μF (333)	V	V
0.047μF (473)	V	V
0.068μF (683)	V	V
0.10μF (104)	V	V

1. The letter in cell is expressed the symbol of product thickness.
2. For more information about products with special capacitance or other data, please contact WTC local representative.

### FEATURES

- \* High voltage in a given case size.
- \* High stability and reliability.

### GENERAL ELECTRICAL DATA

Dielectric	NPO	X7R	Y5V
Size	0603, 0805, 1206, 1210, 1808, 1812		0805, 1206, 1210, 1812
Capacitance	0.5pF to 6800pF		0.01μF to 0.68μF
Capacitance tolerance	Cap≤5pF: C (±0.25pF) 5pF<Cap<10pF: D (±0.5pF) Cap≥10pF: J (±5%), K (±10%)		K (±10%), M (±20%) Z (-20/+80%)
Rated voltage (WVDC)	200V to 3kV		200V, 250V
DF/ Q	Cap<30pF: Q≥400+20C Cap≥30pF: Q≥1000		≤2.5% ≤5%
Insulation resistance at Ur	Ur=200~630V: ≥10GΩ or RxC≥100Ω-F whichever is smaller Ur=1000~3000V: ≥10GΩ		
Dielectric strength	200~300V: ≥2 x WVDC 500~999V: ≥1.5 x WVDC 1000~3000V: ≥1.2 x WVDC		
Operating temperature	-55 to +125°C		-25 to +85°C
Capacitance characteristic	±30ppm		±15% +30/-80%
Termination	Ni/Sn (lead-free termination)		

### EXPLANATION OF PART NUMBERS

1808	N	100	J	202	C	T
Size (Inch (mm))	Dielectric	Capacitance	Tolerance	Rated voltage	Termination	Packaging style
1808 (4520)	N=NPO(C0G)	100=10x10 <sup>0</sup> =10pF	J=±5%	202=2000 VDC	C=Cu/Ni/Sn	T=7" reeled

Please refer to page 2 "How to order" for more information.

### CAPACITANCE RANGE

#### Y5V Dielectric 200V to 250V

DIELECTRIC	Y5V							
SIZE	0805		1206		1210		1812	
RATED VOLTAGE (VDC)	200	250	200	250	200	250	200	250
0.010μF (103)	B	B	B	B	C	C	D	D
0.015μF (153)	B	B	B	B	C	C	D	D
0.022μF (223)	B	B	B	B	C	C	D	D
0.033μF (333)	B	B	B	B	C	C	D	D
0.047μF (473)	B	B	B	B	C	C	D	D
0.068μF (683)	B	B	B	B	C	C	D	D
0.10μF (104)			B	B	C	C	D	D
0.15μF (154)			C	C	C	C	D	D
0.22μF (224)							D	D
0.33μF (334)							D	D
0.47μF (474)							D	D
0.68μF (684)							D	D

1. The letter in cell is expressed the symbol of product thickness.
2. For more information about products with special capacitance or other data, please contact WTC local representative.







### FEATURES

- \* High Q and low ESR performance at high frequency.
- \* Quality improvement of telephone calls for low power loss and better performance.

### GENERAL ELECTRICAL DATA

Dielectric	NPO
Size	0402, 0603, 0805
Capacitance	0402: 0.1pF to 470pF 0603: 0.5pF to 3300pF 0805: 0.5pF to 150pF
Capacitance tolerance	Cap≤5pF: B (±0.1pF), C (±0.25pF) 5pF<Cap<10pF: C (±0.25pF), D (±0.5pF) Cap≥10pF: F (±1%), G (±2%), J (±5%)
Rated voltage (WVDC)	16V, 25V, 50V, 100V, 200V, 250V, 500V, 630V
Q	Cap<30pF: Q≥400+20C Cap≥30pF: Q≥1000
Insulation resistance at Ur	≥10GΩ
Operating temperature	-55 to +125°C
Capacitance change	±30ppm
Termination	Ni/Sn (lead-free termination)

### EXPLANATION OF PART NUMBERS

HH	15	N	100	G	500	C	T
Series HH=High Q/ Low ESR	Size (Inch (mm)) 15=0402 (1005)	Dielectric N=NPO(C0G)	Capacitance 100=10x10 <sup>0</sup> =10pF	Tolerance G=±2%	Rated voltage 500=50 VDC	Termination C=Cu/Ni/Sn	Packaging T=7" reeled

\* Please refer to page 2 "How to order" for more information.

### ELECTRICAL CHARACTERISTICS

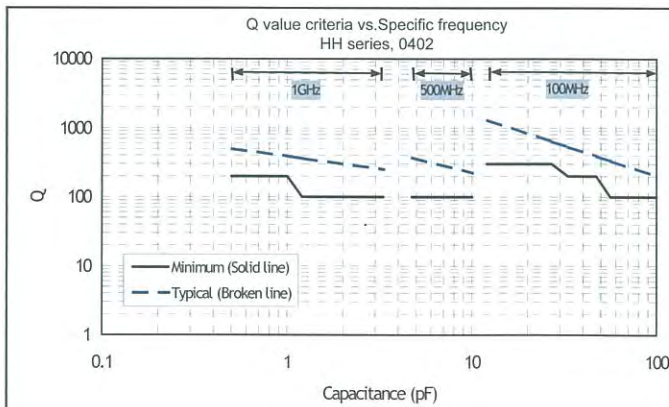

Fig. 1 Q factor specification vs. Specific frequency 0402

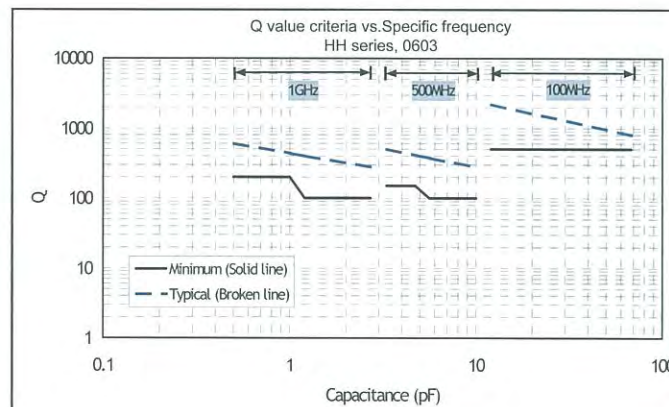

Fig. 2 Q factor specification vs. Specific frequency 0603

### CAPACITANCE RANGE

DIELECTRIC	NPO											
	SIZE	0402				0603				0805		
RATED VOLTAGE (VDC)	16	25	50	100	16	25	50	100	50	100	200,250	500,630
0.1pF (0R1)	N^	N^	N^	N^								
0.2pF (0R2)	N^	N^	N^	N^								
0.3pF (0R3)	N^	N^	N^	N^								
0.4pF (0R4)	N^	N^	N^	N^								
0.5pF (0R5)	N^	N^	N^	N^	S^	S^	S^	S^	B	B		
0.6pF (0R6)	N^	N^	N^	N^	S^	S^	S^	S^	B	B		
0.7pF (0R7)	N^	N^	N^	N^	S^	S^	S^	S^	B	B		
0.8pF (0R8)	N^	N^	N^	N^	S^	S^	S^	S^	B	B		
0.9pF (0R9)	N^	N^	N^	N^	S^	S^	S^	S^	B	B		
1.0pF (1R0)	N^	N^	N^	N^	S^	S^	S^	S^	B	B	B	B
1.2pF (1R2)	N^	N^	N^	N^	S^	S^	S^	S^	B	B	B	B
1.5pF (1R5)	N^	N^	N^	N^	S^	S^	S^	S^	B	B	B	B
1.8pF (1R8)	N^	N^	N^	N^	S^	S^	S^	S^	B	B	B	B
2.0pF (2R0)	N^	N^	N^	N^	S^	S^	S^	S^	B	B	B	B
2.2pF (2R2)	N^	N^	N^	N^	S^	S^	S^	S^	B	B	B	B
2.7pF (2R7)	N^	N^	N^	N^	S^	S^	S^	S^	B	B	B	B
3.0pF (3R0)	N^	N^	N^	N^	S^	S^	S^	S^	B	B	B	B
3.3pF (3R3)	N^	N^	N^	N^	S^	S^	S^	S^	B	B	B	B
3.9pF (3R9)	N^	N^	N^	N^	S^	S^	S^	S^	B	B	B	B
4.0pF (4R0)	N^	N^	N^	N^	S^	S^	S^	S^	B	B	B	B
4.7pF (4R7)	N^	N^	N^	N^	S^	S^	S^	S^	B	B	B	B
5.0pF (5R0)	N^	N^	N^	N^	S^	S^	S^	S^	B	B	B	B
5.6pF (5R6)	N^	N^	N^	N^	S^	S^	S^	S^	B	B	B	B
6.0pF (6R0)	N^	N^	N^	N^	S^	S^	S^	S^	B	B	B	B
6.8pF (6R8)	N^	N^	N^	N^	S^	S^	S^	S^	B	B	B	B
7.0pF (7R0)	N^	N^	N^	N^	S^	S^	S^	S^	B	B	B	B
8.0pF (8R0)	N^	N^	N^	N^	S^	S^	S^	S^	B	B	B	B
8.2pF (8R2)	N^	N^	N^	N^	S^	S^	S^	S^	B	B	B	B
9.0pF (9R0)	N^	N^	N^	N^	S^	S^	S^	S^	B	B	B	B
10pF (100)	N	N	N	N	S	S	S	S	B	B	B	B
12pF (120)	N	N	N	N	S	S	S	S	B	B	B	B
15pF (150)	N	N	N	N	S	S	S	S	B	B	B	B
18pF (180)	N	N	N	N	S	S	S	S	B	B	B	B
22pF (220)	N	N	N	N	S	S	S	S	B	B	B	B
27pF (270)	N	N	N	N	S	S	S	S	B	B	B	B
33pF (330)	N	N	N	N	S	S	S	S	B	B	B	B
39pF (390)	N	N	N	N	S	S	S	S	B	B	B	B
47pF (470)	N	N	N	N	S	S	S	S	B	B	B	B
56pF (560)	N	N	N	N	S	S	S	S	B	B	B	B
68pF (680)	N	N	N	N	S	S	S	S	B	B	B	B
82pF (820)	N	N	N	N	S	S	S	S	B	B	B	B
100pF (101)	N	N	N	N	S	S	S	S	B	B	B	B
120pF (121)	N	N	N	N	S	S	S	S	D	D	D	D
150pF (151)	N	N	N	N	S	S	S	S	D	D	D	D
180pF (181)	N	N	N	N	S	S	S	S			D	D
220pF (221)	N	N	N	N	S	S	S	S			D	D
270pF (271)	N	N	N	N	S	S	S	S			D	D
330pF (331)	N	N	N	N	S	S	S	S			D	D
390pF (391)	N	N	N	N	S	S	S	S			D	D
470pF (471)	N	N	N	N	S	S	S	S				
560pF (561)					S	S	S	S				
680pF (681)					S	S	S	S				
820pF (821)					S	S	S	S				
1,000pF (102)					S	S	S	S				
1,200pF (122)					X	X	X					
1,500pF (152)					X	X	X					
1,800pF (182)					X	X	X					
2,200pF (222)					X	X	X					
2,700pF (272)					X	X	X					
3,300pF (332)					X	X	X					

1. The letter in cell is expressed the symbol of product thickness.
2. The letter in cell with "A" mark is expressed product with Ag/Ni/Sn terminations.
3. For more information about products with special capacitance or other data, please contact WTC local representative.





## FEATURES

- \* Ultra high Q and low ESR performance at high frequency.
- \* Quality improvement of telephone calls for low power loss and better performance.

## GENERAL ELECTRICAL DATA

Dielectric	NPO
Size	0201, 0402, 0603, 0805
Capacitance	0.1pF to 100pF
Capacitance tolerance	Cap≤5pF: A (±0.05pF), B (±0.1pF), C (±0.25pF) 5pF<Cap<10pF: B (±0.1pF), C (±0.25pF), D (±0.5pF) Cap≥10pF: F (±1%), G (±2%), J (±5%)
Rated voltage (WVDC)	6.3V, 10V, 25V, 50V, 100V, 250V, 500V
Q	Cap≥30pF, Q≥1000 Cap<30pF, Q≥400+20C
Insulation resistance at Ur	≥10GΩ
Operating temperature	-55 to +125°C
Capacitance change	±30ppm/°C; 0201Cap≥22pF, ±60ppm/°C
Termination	Ni/Sn (lead-free termination)

## EXPLANATION OF PART NUMBERS

RF	15	N	100	G	500	C	T
Series RF=Microwave	Size (Inch (mm)) 15=0402 (1005)	Dielectric N=NPO	Capacitance 100=10x10 <sup>0</sup> =10pF	Tolerance G=±2%	Rated voltage 500=50 VDC	Termination C=Cu/Ni/Sn	Packaging T=7" reeled

\* Please refer to page 2 "How to order" for more information.

## ELECTRICAL CHARACTERISTICS

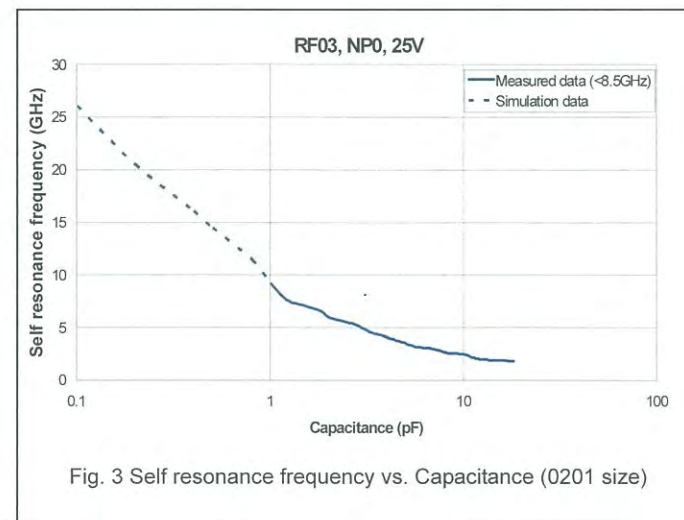

Fig. 3 Self resonance frequency vs. Capacitance (0201 size)

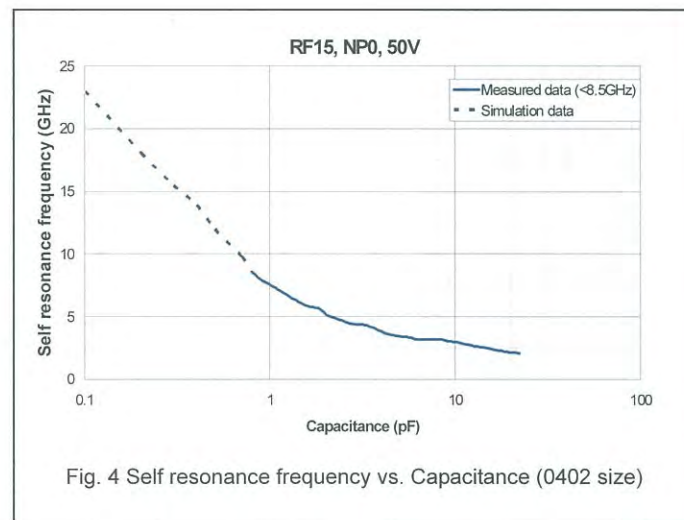

Fig. 4 Self resonance frequency vs. Capacitance (0402 size)

## CAPACITANCE RANGE

DIELECTRIC	NPO													
	0201				0402			0603			0805			
SIZE	6.3	10	25	50	25	50	100	50	100	250	50	100	250	500
RATED VOLTAGE (VDC)														
0.1pF (0R1)	L	L	L	L	N	N	N							
0.2pF (0R2)	L	L	L	L	N	N	N							
0.3pF (0R3)	L	L	L	L	N	N	N	S	S	S	T	T	T	T
0.4pF (0R4)	L	L	L	L	N	N	N	S	S	S	T	T	T	T
0.5pF (0R5)	L	L	L	L	N	N	N	S	S	S	T	T	T	T
0.6pF (0R6)	L	L	L	L	N	N	N	S	S	S	T	T	T	T
0.7pF (0R7)	L	L	L	L	N	N	N	S	S	S	T	T	T	T
0.8pF (0R8)	L	L	L	L	N	N	N	S	S	S	T	T	T	T
0.9pF (0R9)	L	L	L	L	N	N	N	S	S	S	T	T	T	T
1.0pF (1R0)	L	L	L	L	N	N	N	S	S	S	T	T	T	T
1.2pF (1R2)	L	L	L	L	N	N	N	S	S	S	T	T	T	T
1.5pF (1R5)	L	L	L	L	N	N	N	S	S	S	T	T	T	T
1.8pF (1R8)	L	L	L	L	N	N	N	S	S	S	T	T	T	T
2.0pF (2R0)	L	L	L	L	N	N	N	S	S	S	T	T	T	T
2.2pF (2R2)	L	L	L	L	N	N	N	S	S	S	T	T	T	T
2.7pF (2R7)	L	L	L	L	N	N	N	S	S	S	T	T	T	T
3.0pF (3R0)	L	L	L	L	N	N	N	S	S	S	T	T	T	T
3.3pF (3R3)	L	L	L	L	N	N	N	S	S	S	T	T	T	T
3.9pF (3R9)	L	L	L	L	N	N	N	S	S	S	T	T	T	T
4.0pF (4R0)	L	L	L	L	N	N	N	S	S	S	T	T	T	T
4.7pF (4R7)	L	L	L	L	N	N	N	S	S	S	T	T	T	T
5.0pF (5R0)	L	L	L	L	N	N	N	S	S	S	T	T	T	T
5.6pF (5R6)	L	L	L	L	N	N	N	S	S	S	T	T	T	T
6.0pF (6R0)	L	L	L	L	N	N	N	S	S	S	T	T	T	T
6.8pF (6R8)	L	L	L	L	N	N	N	S	S	S	T	T	T	T
7.0pF (7R0)	L	L	L	L	N	N	N	S	S	S	T	T	T	T
8.0pF (8R0)	L	L	L	L	N	N	N	S	S	S	T	T	T	T
8.2pF (8R2)	L	L	L	L	N	N	N	S	S	S	T	T	T	T
9.0pF (9R0)	L	L	L	L	N	N	N	S	S	S	T	T	T	T
10pF (100)	L	L	L	L	N	N	N	S	S	S	T	T	T	T
11pF (110)	L	L	L	L	N	N	N	S	S	S	T	T	T	T
12pF (120)	L	L	L	L	N	N	N	S	S	S	T	T	T	T
13pF (130)	L	L	L	L	N	N	N	S	S	S	T	T	T	T
15pF (150)	L	L	L	L	N	N	N	S	S	S	T	T	T	T
16pF (160)	L	L	L	L	N	N	N	S	S	S	T	T	T	T
18pF (180)	L	L	L	L	N	N	N	S	S	S	T	T	T	T
20pF (200)	L	L	L	L	N	N	N	S	S	S	T	T	T	T
22pF (220)	L	L	L		N	N	N	S	S	S	T	T	T	T
24pF (240)	L	L	L		N	N	N	S	S	S	T	T	T	T
27pF (270)	L	L	L		N	N	N	S	S	S	T	T	T	T
30pF (300)	L	L	L		N	N	N	S	S	S	T	T	T	T
33pF (330)	L	L	L		N	N	N	S	S	S	T	T	T	T
36pF (360)					N	N	N	S	S	S	T	T	T	T
39pF (390)					N	N	N	S	S	S	T	T	T	T
43pF (430)					N	N	N	S	S	S	T	T	T	T
47pF (470)					N	N	N	S	S	S	T	T	T	T
56pF (560)					N	N	N				T	T	T	T
68pF (680)					N						T	T	T	T
82pF (820)					N						T	T	T	T
100pF (101)					N						T	T	T	T

1. The letter in cell is expressed the symbol of product thickness.
2. For more information about products with special capacitance or other data, please contact WTC local representative.



### FEATURES

- \* MLCC's terminations build a soft & flexible polymer layer to withstand high bending stress in SMT line.
- \* Available for any item in standard series range.

### GENERAL ELECTRICAL DATA

Dielectric	NPO	X7R
Size	0603, 0805, 1206, 1210, 1808, 1812	
Capacitance range	0.5pF to 0.015pF	100pF to 10µF
Capacitance tolerance	Cap≤5pF: B (±0.1pF), C (±0.25pF) 5pF<Cap<10pF: C (±0.25pF), D (±0.5pF) Cap≥10pF: F (±1%), G (±2%), J (±5%), K (±10%)	J (±5%), K (±10%), M (±20%)
Rated voltage (WVDC)	10V, 16V, 25V, 50V, 100V, 200V, 250V, 500V, 630V, 1000V, 2000V, 3000V	
Operating temperature	-55 to +125°C	
Capacitance characteristic	±30ppm	±15%
Termination	Ni/Sn (lead-free termination)	

### EXPLANATION OF PART NUMBERS

SH	31	N	100	D	501	C	T
<b>Series</b>	<b>Size (Inch (mm))</b>	<b>Dielectric</b>	<b>Capacitance</b>	<b>Tolerance</b>	<b>Rated voltage</b>	<b>Termination</b>	<b>Packaging</b>
SH=With Ag polymer SG=With Cu polymer	31=1206 (3216)	N=NPO(C0G)	100=10x10 <sup>0</sup> =10pF	D=±0.5pF	501=50 VDC	C=Cu/Ni/Sn	T=7" reeled

\* Please refer to page 2 " How to order" for more information.

### PACKAGING DIMENSION AND QUANTITY

Size	L(mm)	W(mm)	Thickness (mm)/Symbol	Paper tape		Plastic tape		
				7" reel	13" reel	7" reel	13" reel	
0402 (1005)	1.00±0.20	0.50±0.20	0.50±0.20	E	1,000	-	-	
	1.60±0.20	0.80±0.10	0.80±0.07	S	4,000	15,000	-	
0603 (1608)	1.60±0.20/-0.10	0.80±0.15/-0.10	0.80±0.15/-0.10	X	4,000	15,000	-	
			0.60±0.10	A	4,000	15,000	-	
0805 (2012)	2.00±0.20	1.25±0.10	0.80±0.10	B	4,000	15,000	-	
			1.25±0.10	D	-	-	3,000	10,000
			1.25±0.20	I	-	-	3,000	10,000
			0.80±0.10	B	4,000	15,000	-	-
1206 (3216)	3.20±0.4/-0.1	1.60±0.15	0.95±0.10	C	-	-	3,000	10,000
			1.15±0.15	J	-	-	3,000	10,000
			1.25±0.10	D	-	-	3,000	10,000
			1.60±0.20	G	-	-	2,000	10,000
			1.60±0.30/-0.10	P	-	-	2,000	9,000
1210 (3225)	3.20±0.40	2.50±0.20	0.95±0.10	C	-	-	3,000	10,000
			1.25±0.10	D	-	-	3,000	10,000
			1.60±0.20	G	-	-	2,000	10,000
			2.00±0.20	K	-	-	1,000	6,000
			2.50±0.30	M	-	-	1,000	6,000
1808 (4520)	4.50±0.60/-0.4	2.03±0.25	1.25±0.10	D	-	-	2,000	-
			2.00±0.20	K	-	-	1,000	-
1812 (4532)	4.50±0.60/-0.4	3.20±0.30	1.25±0.10	D	-	-	1,000	-
			2.00±0.20	K	-	-	1,000	-
			2.50±0.30	M	-	-	500	3,000

Unit: pieces

### CAPACITANCE RANGE(SH Series)

#### NPO Dielectric

DIELECTRIC	SIZE	NPO																	
		0402		0603		0805		1206				1210				1808			
RATED VOLTAGE (VDC)	10, 16, 25, 50	100	10, 16, 25, 50	200, 250	10, 16, 25, 50, 100	200	250, 500, 600	10, 16, 25, 50, 100	200	250, 500, 600	1000	2000	10, 16, 25, 50, 100	200	500, 600	1000	2000	500, 630, 1000, 2000	3000
0.5pF (0R5)	E	E	S	S	A	A	A												
1.0pF (1R0)	E	E	S	S	A	A	A												
1.2pF (1R2)	E	E	S	S	A	A	A												
1.5pF (1R5)	E	E	S	S	A	A	A	B	B	B	B	B							
1.8pF (1R8)	E	E	S	S	A	A	A	B	B	B	B	B							
2.2pF (2R2)	E	E	S	S	A	A	A	B	B	B	B	B							D
2.7pF (2R7)	E	E	S	S	A	A	A	B	B	B	B	B							D
3.3pF (3R3)	E	E	S	S	A	A	A	B	B	B	B	B							D
3.9pF (3R9)	E	E	S	S	A	A	A	B	B	B	B	B							D
4.7pF (4R7)	E	E	S	S	A	A	A	B	B	B	B	B							D
5.6pF (5R6)	E	E	S	S	A	A	A	B	B	B	B	B							D
6.8pF (6R8)	E	E	S	S	A	A	A	B	B	B	B	B							D
8.2pF (8R2)	E	E	S	S	A	A	A	B	B	B	B	B							D
10pF (100)	E	E	S	S	A	A	A	B	B	B	B	B	C	C	C	C	C	C	D
12pF (120)	E	E	S	S	A	A	A	B	B	B	B	B	C	C	C	C	C	C	D
15pF (150)	E	E	S	S	A	A	A	B	B	B	B	B	C	C	C	C	C	C	D
18pF (180)	E	E	S	S	A	A	A	B	B	B	B	B	C	C	C	C	C	C	D
22pF (220)	E	E	S	S	A	A	A	B	B	B	B	B	C	C	C	C	C	C	D
27pF (270)	E	E	S	S	A	A	A	B	B	B	B	B	C	C	C	C	C	C	D
33pF (330)	E	E	S	S	A	A	A	B	B	B	B	B	C	C	C	C	C	C	D
39pF (390)	E	E	S	S	A	A	A	B	B	B	B	B	C	C	C	C	C	C	D
47pF (470)	E	E	S	S	A	A	A	B	B	B	B	B	C	C	C	C	C	C	D
56pF (560)	E	E	S	S	A	A	A	B	B	B	B	B	C	D	C	C	C	C	D
68pF (680)	E	E	S	S	A	A	A	B	B	B	B	B	C	D	C	C	C	C	D
82pF (820)	E	E	S	S	A	A	A	B	B	B	B	B	D	D	C	C	C	C	D
100pF (101)	E	E	S	S	A	A	B	B	B	B	B	D	D	C	C	C	D	D	K
120pF (121)	E	E	S	S	A	A	D	B	B	B	D	G	C	C	C	D	D		
150pF (151)	E	E	S	S	A	B	D	B	B	B	D	G	C	C	C	D	G		
180pF (181)	E	E	S	S	A	B	D	B	B	B	G	G	C	C	C	D	G		
220pF (221)	E	E	S	S	A	D	D	B	B	B	G	G	C	C	C	G	G		
270pF (271)	E		S	X	A	D	D	B	B	C	G		C	C	C	G			
330pF (331)	E		S	X	A	D	D	B	B	C	G		C	C	C	G			
390pF (391)	E		S	X	B	D	D	B	B	C			C	C	C	G			
470pF (471)	E		S	X	B	D		B	C	C			C	C	C	G			
560pF (561)	E		S		B	D		B	C	D			C	C	C				
680pF (681)	E		S		B	D		B	C	D			C	C	C				
820pF (821)	E		S		B	D		B	C	G			C	C	C				
1,000pF (102)	E		S		B	D		B	C	G			C	D	D				
1,200pF (122)									B	C	G			C	D	D			
1,500pF (152)									B	D	G			C	D	D			
1,800pF (182)									B	D	G			C	D	D			
2,200pF (222)									B	D	G			C	D				
2,700pF (272)									B	D				C	D				
3,300pF (332)									B	D				C	D				
3,900pF (392)									B	D				C	D				
4,700pF (472)									B	D				C					
5,600pF (562)														C					
6,800pF (682)														C					
8,200pF (822)														C					
0.010µF (103)														C					
0.012µF (123)														D					
0.015µF (153)														D					

1. The letter in cell is expressed the symbol of product thickness.

2. For more information about products with special capacitance or other data, please contact WTC local representative.







## ■ CAPACITANCE RANGE (SG Series) NP0 Dielectric

DIELECTRIC	NP0							
	0603				0805			
	10	16	25	50	10	16	25	50
SIZE								
RATED VOLTAGE (VDC)								
0.1pF (0R1)								
0.2pF (0R2)								
0.3pF (0R3)								
0.4pF (0R4)								
0.5pF (0R5)	S	S	S	S	A	A	A	A
0.6pF (0R6)	S	S	S	S	A	A	A	A
0.7pF (0R7)	S	S	S	S	A	A	A	A
0.8pF (0R8)	S	S	S	S	A	A	A	A
0.9pF (0R9)	S	S	S	S	A	A	A	A
1.0pF (1R0)	S	S	S	S	A	A	A	A
1.2pF (1R2)	S	S	S	S	A	A	A	A
1.5pF (1R5)	S	S	S	S	A	A	A	A
1.8pF (1R8)	S	S	S	S	A	A	A	A
2.2pF (2R2)	S	S	S	S	A	A	A	A
2.7pF (2R7)	S	S	S	S	A	A	A	A
3.3pF (3R3)	S	S	S	S	A	A	A	A
3.9pF (3R9)	S	S	S	S	A	A	A	A
4.7pF (4R7)	S	S	S	S	A	A	A	A
5.6pF (5R6)	S	S	S	S	A	A	A	A
6.8pF (6R8)	S	S	S	S	A	A	A	A
8.2pF (8R2)	S	S	S	S	A	A	A	A
10pF (100)	S	S	S	S	A	A	A	A
12pF (120)	S	S	S	S	A	A	A	A
15pF (150)	S	S	S	S	A	A	A	A
18pF (180)	S	S	S	S	A	A	A	A
22pF (220)	S	S	S	S	A	A	A	A
27pF (270)	S	S	S	S	A	A	A	A
33pF (330)	S	S	S	S	A	A	A	A
39pF (390)	S	S	S	S	A	A	A	A
47pF (470)	S	S	S	S	A	A	A	A
56pF (560)	S	S	S	S	A	A	A	A
68pF (680)	S	S	S	S	A	A	A	A
82pF (820)	S	S	S	S	A	A	A	A
100pF (101)	S	S	S	S	A	A	A	A
120pF (121)	S	S	S	S	A	A	A	A
150pF (151)	S	S	S	S	A	A	A	A
180pF (181)	S	S	S	S	A	A	A	A
220pF (221)	S	S	S	S	A	A	A	A
270pF (271)	S	S	S	S	A	A	A	A
330pF (331)	S	S	S	S	A	A	A	A
390pF (391)	S	S	S	S	B	B	B	B
470pF (471)	S	S	S	S	B	B	B	B
560pF (561)	S	S	S	S	B	B	B	B
680pF (681)	S	S	S	S	B	B	B	B
820pF (821)	S	S	S	S	B	B	B	B
1,000pF (102)	S	S	S	S	B	B	B	B
1,200pF (122)	X	X	X	X	B	B	B	B
1,500pF (152)	X	X	X	X	B	B	B	B
1,800pF (182)	X	X	X	X	B	B	B	B
2,200pF (222)	X	X	X	X	B	B	B	B
2,700pF (272)					D	D	D	D
3,300pF (332)					D	D	D	D
3,900pF (392)					D	D	D	D
4,700pF (472)					D	D	D	D
5,600pF (562)					D	D	D	D
6,800pF (682)					D	D	D	D
8,200pF (822)					D	D	D	D
0.010uF (103)					D	D	D	D
0.012uF (123)					D	D	D	D

1. The letter in cell is expressed the symbol of product thickness.  
2. For more information about products with special capacitance or other data, please contact WTC local representative.

## ■ CAPACITANCE RANGE (SG Series) X7R Dielectric

DIELECTRIC	X7R			
	0603			
	10	16	25	50
SIZE				
RATED VOLTAGE (VDC)				
100pF (101)	S	S	S	S
120pF (121)	S	S	S	S
150pF (151)	S	S	S	S
180pF (181)	S	S	S	S
220pF (221)	S	S	S	S
270pF (271)	S	S	S	S
330pF (331)	S	S	S	S
390pF (391)	S	S	S	S
470pF (471)	S	S	S	S
560pF (561)	S	S	S	S
680pF (681)	S	S	S	S
820pF (821)	S	S	S	S
1,000pF (102)	S	S	S	S
1,200pF (122)	S	S	S	S
1,500pF (152)	S	S	S	S
1,800pF (182)	S	S	S	S
2,200pF (222)	S	S	S	S
2,700pF (272)	S	S	S	S
3,300pF (332)	S	S	S	S
3,900pF (392)	S	S	S	S
4,700pF (472)	S	S	S	S
5,600pF (562)	S	S	S	S
6,800pF (682)	S	S	S	S
8,200pF (822)	S	S	S	S
0.010uF (103)	S	S	S	S
0.012uF (123)	S	S	S	S
0.015uF (153)	S	S	S	S
0.018uF (183)	S	S	S	S
0.022uF (223)	S	S	S	S
0.027uF (273)	S	S	S	S
0.033uF (333)	S	S	S	X
0.039uF (393)	S	S	S	X
0.047uF (473)	S	S	S	X
0.056uF (563)	S	S	S	X
0.068uF (683)	S	S	S	X
0.082uF (823)	S	S	S	X
0.10uF (104)	S	S	S	X
0.12uF (124)				
0.15uF (154)				
0.18uF (184)				
0.22uF (224)				
0.27uF (274)				
0.33uF (334)				
0.39uF (394)				
0.47uF (474)				
0.56uF (564)				
0.68uF (684)				
0.82uF (824)				
1.0uF (105)				

1. The letter in cell is expressed the symbol of product thickness.  
2. For more information about products with special capacitance or other data, please contact WTC local representative.

## Y5V Dielectric

DIELECTRIC	Y5V	
	0603	
	10	16
SIZE		
RATED VOLTAGE (VDC)		
0.010uF (103)	S	S
0.015uF (153)	S	S
0.022uF (223)	S	S
0.033uF (333)	S	S
0.047uF (473)	S	S
0.068uF (683)	S	S
0.10uF (104)	S	S
0.15uF (154)	S	S
0.22uF (224)	S	S
0.33uF (334)	S	S
0.47uF (474)	S	S
0.68uF (684)	S	X
1.0uF (105)	S	X



## FEATURES

- \* High voltage in a given case size.
- \* Circuit open during product cracking.
- \* High stability and reliability.

## GENERAL ELECTRICAL DATA

Dielectric	X7R
Size	0805, 1206, 1210, 1812
Capacitance	100pF to 1μF
Capacitance tolerance	K (±10%), M (±20%)
Rated voltage (WVDC)	50V, 100V, 200V, 250V, 500V
DF(Tan δ)	≤2.5%
Insulation resistance at Ur	≥10GΩ or RxC≥500Ω·F whichever is smaller
Dielectric strength	100V: ≥2.5 x WVDC 200V and 250V: ≥2 x WVDC 500V: ≥1.5 x WVDC
Operating temperature	-55 to +125°C
Capacitance characteristic	±15%
Termination	Ni/Sn (lead-free termination)

## EXPLANATION OF PART NUMBERS

OP	32	B	103	K	201	C	T
Series	Size (Inch (mm))	Dielectric	Capacitance	Tolerance	Rated voltage	Termination	Packaging
OP=Open-mode	32=1210 (3225)	B=X7R	103=10x10 <sup>3</sup> =10nF	K=±10%	201=200 VDC	C=Cu/Ni/Sn	T=7" reeled

\* Please refer to page 2 "How to order" for more information.

## INNER CONSTRUCTION OF OPEN-MODE DESIGN

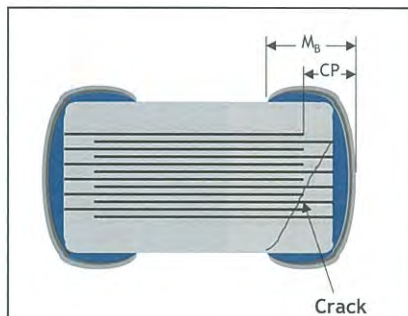

Fig. 5 Normal design (CP<Mb) – circuit leakage during cracking.

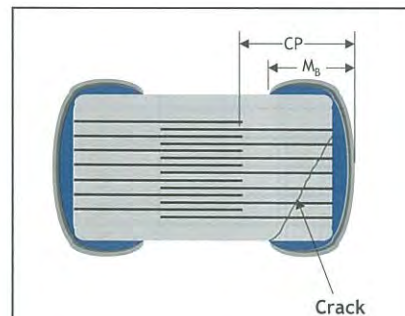

Fig. 6 Open-mode design (CP>Mb) – circuit open during cracking.

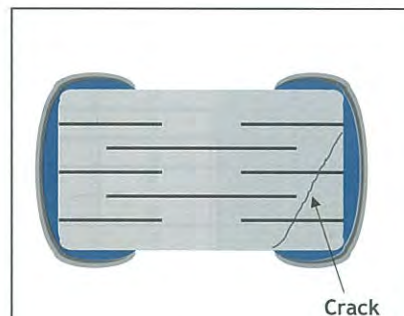

Fig. 7 Floating design (one kind of open-mode design) – circuit open during cracking.

## CAPACITANCE RANGE

DIELECTRIC	X7R																
	0805				1206				1210				1812				
SIZE	100	200	250	500	50	100	200	250	500	100	200	250	500	100	200	250	500
RATED VOLTAGE (VDC)	100	200	250	500	50	100	200	250	500	100	200	250	500	100	200	250	500
100pF (101)	B	B	B	B													
120pF (121)	B	B	B	B													
150pF (151)	B	B	B	B	B	B	D	D	D								
180pF (181)	B	B	B	B	B	B	D	D	D								
220pF (221)	B	B	B	B	B	B	D	D	D								
270pF (271)	B	B	B	B	B	B	D	D	D								
330pF (331)	B	B	B	B	B	B	D	D	D								
390pF (391)	B	B	B	B	B	B	D	D	D								
470pF (471)	B	B	B	B	B	B	D	D	D								
560pF (561)	B	B	B	B	B	B	D	D	D								
680pF (681)	B	B	B	B	B	B	D	D	D								
820pF (821)	B	B	B	B	B	B	D	D	D								
1,000pF (102)	B	B	B	B	B	B	D	D	D	C	C	C	D	D	D	D	D
1,200pF (122)	B	B	B	B	B	B	D	D	D	C	C	C	D	D	D	D	D
1,500pF (152)	B	B	B	B	B	B	D	D	D	C	C	C	D	D	D	D	D
1,800pF (182)	B	B	B	B	B	B	D	D	D	C	C	C	D	D	D	D	D
2,200pF (222)	B	B	B	B	B	B	D	D	D	C	C	C	D	D	D	D	D
2,700pF (272)	B	B	B	B	B	B	D	D	D	C	C	C	D	D	D	D	D
3,300pF (332)	B	B	B	B	B	B	D	D	D	C	C	C	D	D	D	D	D
3,900pF (392)	B	B	B	B	B	B	D	D	D	C	C	C	D	D	D	D	D
4,700pF (472)	B	B	B	D	B	B	D	D	D	C	C	C	D	D	D	D	D
5,600pF (562)	B	D	D	D	B	B	D	D	D	C	C	C	D	D	D	D	D
6,800pF (682)	B	D	D	D	B	B	D	D	D	C	C	C	D	D	D	D	D
8,200pF (822)	B	D	D	D	B	B	D	D	D	C	C	C	D	D	D	D	D
0.010μF (103)	B	D	D	D	B	B	D	D	D	C	C	C	D	D	D	D	D
0.012μF (123)	B	D	D		B	B	D	D	D	C	C	C	D	D	D	D	D
0.015μF (153)	B	D	D		B	B	D	D	D	C	C	C	D	D	D	D	D
0.018μF (183)	B	D	D		B	B	D	D	D	C	C	C	D	D	D	D	D
0.022μF (223)	B	D	D		B	B	D	D	G	C	C	C	D	D	D	D	D
0.027μF (273)	D				B	B	D	D	G	C	C	C	D	D	D	D	D
0.033μF (333)	D				B	B	G	G	G	C	C	C	G	D	D	D	D
0.039μF (393)	D				B	B	G	G		C	C	C	G	D	D	D	D
0.047μF (473)	D				B	B	G	G		C	D	D	G	D	D	D	D
0.056μF (563)					B	B	G	G		C	D	D	G	D	D	D	K
0.068μF (683)					B	B	G	G		C	G	G	G	D	D	D	K
0.082μF (823)					D	D	G	G		C	G	G		D	D	D	K
0.10μF (104)					D	D	G	G		C	G	G		D	D	D	K
0.12μF (124)					D	D				C	G	G		D	D	D	
0.15μF (154)					D	G				D	M	M		D	K	K	
0.18μF (184)					D	G				D	M	M		D	K	K	
0.22μF (224)					D	G				D	M	M		D	K	K	
0.27μF (274)					D					G				D	K	K	
0.33μF (334)					D					G				D	K	K	
0.39μF (394)					D					M				D	K	K	
0.47μF (474)					D					M				K	K	K	
0.56μF (564)										M				K			
0.68μF (684)														K			
0.82μF (824)														K			
1.0μF (105)														K			

1. The letter in cell is expressed the symbol of product thickness.
2. For more information about products with special capacitance or other data, please contact WTC local representative.



## FEATURES

- \* High density mounting due to mounting space saving.
- \* Mounting cost saving.
- \* Increased throughput.

## GENERAL ELECTRICAL DATA

Dielectric	NP0		X7R		Y5V
Size	4x0402	4x0603	4x0402	4x0603	4x0603
Capacitance*	10pF to 270pF	10pF to 470pF	1000pF to 100nF	180pF to 100nF	10nF to 100nF
Capacitance tolerance**	J (±5%), K (±10%)		K (±10%), M (±20%)		Z (-20/+80%)
Rated voltage (WVDC)	25,50V,100V	25, 50V,100V	10V, 16V, 25V, 50V	16V, 25V, 50V	16V, 50V
Q/DF(Tan δ)*	Cap<30pF: Q≥400+20C Cap≥30pF: Q≥1000		Ur=50V, ≤2.5% Ur=25V&16V, ≤3.5% Ur=10V, ≤5.0%		Ur=50V, ≤5% Ur=16V, ≤7%
Insulation resistance at Ur	≥10GΩ		≥10GΩ or RxC≥500ΩxF whichever is less		
Operating temperature	-55 to +125°C				-25 to +85°C
Capacitance characteristic	±30ppm		±15%		+30/-80%
Termination	Ni/Sn (lead-free termination)				

## EXPLANATION OF PART NUMBERS

Y	4C	3	B	103	K	500	C	T
Series	Cap. Nr.	Termination pitch	Dielectric	Capacitance	Tolerance	Rated voltage	Termination	Packaging
Y=Capacitor array	4C=4xCap	3=0.03" pitch 2=0.02" pitch	B=X7R	103=10x10 <sup>3</sup> =10nF	K=±10%	500=50 VDC	C=Cu/Ni/Sn	T=7" reeled

\* Please refer to page 2 " How to order" for more information.

## CAPACITANCE RANGE

SIZE	4 x 0402					4 x 0603						
	Dielectric	NP0		X7R		Dielectric	NP0		X7R		Y5V	
	RATED VOLTAGE (VDC)	25,50,100	10	16	25	50	25,50,100	16	25	50	16	50
10pF (100)	T					B						
15pF (150)	T					B						
22pF (220)	T					B						
33pF (330)	T					B						
47pF (470)	T					B						
68pF (680)	T					B						
100pF (101)	T					B						
150pF (151)	T					B						
180pF (181)	T					B		B	B			
220pF (221)	T					B		B	B			
270pF (271)	T					B		B	B			
330pF (331)						B		B	B			
470pF (471)						B		B	B			
6,80pF (681)								B	B			
1,000pF (102)		T	T	T	T			B	B			
1,500pF (152)		T	T	T	T			B	B			
2,200pF (222)		T	T	T	T			B	B			
3,300pF (332)		T	T	T	T			B	B			
4,700pF (472)		T	T	T	T			B	B			
6,800pF (682)		T	T	T	T			B	B			
0.010μF (103)		T	T	T	T			B	B		B	
0.015μF (153)		T	T	T	T			B	B	B		
0.022μF (223)		T	T	T	T			B	B	B		
0.033μF (333)		T	T	T	T			B	B	B		
0.047μF (473)		T	T	T	T			B	B	B		
0.068μF (683)		T	T	T	T			B	B	B		
0.10μF (104)		T	T	T	T			B	B	B		

- The letter in cell is expressed the symbol of product thickness.
- For more information about products with special capacitance or other data, please contact WTC local representative.

## FEATURES

- \* Standard size with thin thickness.
- \* Small size with high capacitance.
- \* Capacitor with lead-free termination (pure Tin).

## GENERAL ELECTRICAL DATA

Dielectric	X7R	X5R	Y5V
Size	0402, 0603, 0805, 1206, 1210		
Capacitance range	0.22μF to 4.7μF	0.22μF to 22μF	1μF to 10μF
Capacitance tolerance	K (±10%), M (±20%)		Z (-20/+80%)
Rated voltage (WVDC)	6.3V, 10V, 16V, 25V	6.3V, 10V, 16V, 25V, 50V	10V, 16V, 25V, 50V
DF(Tan δ)*	16V, 10V: ≤10.0% 6.3V: ≤15.0%		50V: ≤7% 25V: ≤9% 16V, 10V: ≤12.5%
Insulation resistance at Ur	RxC≥100ΩxF		
Operating temperature	-55 to +125°C	-55 to +85°C	-25 to +85°C
Capacitance characteristic	±15%		+30/-80%
Termination	Ni/Sn (lead-free termination)		

## EXPLANATION OF PART NUMBERS

TT	31	X	225	K	100	C	T
Series	Size (Inch (mm))	Dielectric	Capacitance	Tolerance	Rated voltage	Termination	Packaging
TT=Low profile	31=1206 (3216)	X=X5R	225=22x10 <sup>5</sup> =2.2μF	K=±10%	100=10 VDC	C=Cu/Ni/Sn	T=7" reeled

\* Please refer to page 2 " How to order" for more information.

## CAPACITANCE RANGE

Dielectric	X5R																	
	Size	0402		0603		0805			1206			1210						
	Rated voltage (VDC)	6.3	25	10	16	6.3	10	16	25	6.3	10	16	25	50	10	16	25	
Capacitance	0.22μF (224)		L	H	H													
	0.47μF (474)	L	L															
	1.0μF (105)	L		H	H		T	T	T		T	T	T					
	1.5μF (155)						T	T			T	T	T					
	2.2μF (225)					T	T	T	T		T	T	T	T				
	3.3μF (335)										T	T	T		T			
	4.7μF (475)			H		T	T	T	T		T	T	T		T			
	6.8μF (685)																	
	10μF (106)					T	T	T		J	T		T		T		T	
	22μF (226)					T				T		T					T	
47μF (476)									T									

Dielectric	X7R					Y5V						
	Size	0805		1206		0805			1206		1210	
	Rated voltage (VDC)	10	16, 25	10	25	50	10	16	25	50	10	
Capacitance	1.0μF (105)				T					T		
	1.5μF (155)											
	2.2μF (225)		T			T		T		T	T	T
	3.3μF (335)						T					
	4.7μF (475)	T				T	T			T	T	
	6.8μF (685)									T		
10μF (106)				T			T			T		T
22μF (226)												

- The letter in cell is expressed the symbol of product thickness.
- For more information about products with special capacitance or other data, please contact WTC local representative.



### FEATURES

- \* Standard size with thin thickness.
- \* Small size with high capacitance.
- \* Capacitor with lead-free termination (pure Tin).
- \* MLCC with low ESL performance.

### GENERAL ELECTRICAL DATA

Dielectric	X7R
Size	0612
Capacitance range	10nF to 150nF
Capacitance tolerance	K (±10%), M (±20%)
Rated voltage (WVDC)	50V
DF(Tan δ)*	≤2.5%
Insulation resistance at Ur	≥10GΩ or RxC≥500ΩxF whichever is less
Operating temperature	-55 to +125°C
Capacitance characteristic	±15%
Termination	Ni/Sn (lead-free termination)
ESL	500pH

### EXPLANATION OF PART NUMBERS

0612	B	103	K	500	C	T
Size (Inch (mm))	Dielectric	Capacitance	Tolerance	Rated voltage	Termination	Packaging
0612(1632)	B=X7R	103=10x10 <sup>3</sup> =10nF	K=±10%	500=50 VDC	C=Cu/Ni/Sn	T=7" reeled

\* Please refer to page 2 "How to order" for more information.

### CAPACITANCE RANGE

Capacitance	DIELECTRIC		X7R	
	SIZE		0612	
	RATED VOLTAGE (VDC)		50	
	10nF (103)		B	
	12nF (123)		B	
	15nF (153)		B	
	18nF (183)		B	
	22nF (223)		B	
	27nF (273)		B	
	33nF (333)		B	
	39nF (393)		B	
	47nF (473)		B	
	56nF (563)		B	
	68nF (683)		B	
	82nF (823)		B	
	100nF (104)		B	
	120nF (124)		B	
	150nF (154)		B	

- The letter in cell is expressed the symbol of product thickness.
- For more information about products with special capacitance or other data, please contact WTC local representative.

### FEATURES

- \* High voltage in a given case size.
- \* High stability and reliability.
- \* RoHS compliant.



### GENERAL ELECTRICAL DATA

Dielectric	NPO	X7R
Size	1808, 1812, 2211	1808, 1812, 2220, 2211
Capacitance	4pF to 680pF	100pF to 4700pF
Capacitance tolerance	J (±5%), K (±10%)	
Rated voltage (WVAC)	250Vrms	
Q/ DF (Tan δ)	Cap<30pF: Q≥400+20C	DF≤2.5%
Insulation resistance at Ur	≥10GΩ	
Dielectric withstanding strength	1500VAC	
Peak impulse voltage	5000V	
Operating temperature	-55 to +125°C	
Capacitance characteristic	±60ppm	±15%
Termination	Ni/Sn (lead-free termination)	
Certified number	TUV: R500021351, R50118359, R50195920, UL: E250427, E182369	
Test standard	EN 60384-14:2005, IEC 60384-14:2005, EN 60384-14:2005, UL 60950:2000, UL 60384-14	

### EXPLANATION OF PART NUMBERS

S2	42	N	100	J	302	L	T
Series	Size (Inch (mm))	Dielectric	Capacitance	Tolerance	Rated voltage	Termination	Packaging
S2=X1/Y2	42=1808 (4520)	N=NPO	100=10x10 <sup>0</sup> =10pF	J=±5%	302=3000 VDC 602=6000 Impulse Voltage	L=Ag/Ni/Sn C=Cu/Ni/Sn	T=7" reeled

\* Please refer to page 2 "How to order" for more information.

### CAPACITANCE RANGE

Capacitance	DIELECTRIC		NPO			
	SIZE		2211			
	RATED VOLTAGE (VDC)		3000			
	PEAK IMPULSE VOLTAGE		5000	5000	5000	6000
	4pF (4R0)	F			K	K*
	5pF (5R0)	F			K	K*
	10pF (100)	F	D		K	K*
	12pF (120)	F	D		K	K*
	15pF (150)	F	D		K	K*
	18pF (180)	F	D		K	K*
	22pF (220)	F	D		K	K*
	27pF (270)	F	D		K	K*
	33pF (330)	F	D		K	K*
	39pF (390)	G	D		K	K*
	47pF (470)	G	D		K	K*
	56pF (560)	G	D		K	K*
	68pF (680)	G	D		K	M*
	82pF (820)	G	D		K	M*
	100pF (101)	K	D		K	U*
	120pF (121)	K	D		M	
	150pF (151)	K	D		M	
	180pF (181)		D		M	
	220pF (221)		K		M	
	270pF (271)		K		M	
	330pF (331)		K		M	
	390pF (391)		K		M	
	470pF (471)		K		M	
	560pF (561)				M	
	680pF (681)				M	

Capacitance	DIELECTRIC		X7R			
	SIZE		2211			
	RATED VOLTAGE (VDC)		3000			
	PEAK IMPULSE VOLTAGE		5000			
	56pF (560)					
	68pF (680)					
	82pF (820)					
	100pF (101)	G				
	120pF (121)	G				
	150pF (151)	G	G		G	
	180pF (181)	G	G		G	K
	220pF (221)	G	G		G	K
	270pF (271)	K	G		G	K
	330pF (331)	K	G		G	K
	390pF (391)	K	G		G	K
	470pF (471)	K	G		K	K
	560pF (561)	K	G		K	K
	680pF (681)	K	K		K	K
	820pF (821)	K	K		K	K
	1,000pF (102)	K	M		M	K
	1,200pF (122)				M	M
	1,500pF (152)				M	M
	1,800pF (182)				M	M
	2,200pF (222)				M	M
	3,300pF (332)					M
	4,700pF (472)					M

- The letter in cell is expressed the symbol of product thickness.
- The letter in cell with "\*" mark is expressed product with Cu/Ni/Sn terminations.
- For more information about products with special capacitance or other data, please contact WTC local representative.

### PACKAGING DIMENSION AND QUANTITY ( X1/Y2 & X2/Y3 Series)

Size Inch (mm)	L (mm)	W (mm)	MB min(mm)	T (mm)/Symbol	7" Plastic tape	
1808 (4520)	4.50±0.5/-0.3	2.03±0.25	0.26	1.40±0.15	F	2,000
				1.60±0.20	G	1,000
				2.00±0.20	K	1,000
1812 (4532)	4.50±0.5/-0.3	3.20±0.30	0.26	1.60±0.20	G	1,000
				2.00±0.20	K	1,000
				2.50±0.30	M	500
2220 (5750)	5.70±0.40	5.00±0.40	0.30	2.00±0.20	K	1,000
				2.50±0.30	M	500
				1.60±0.20	G	1,000
2211 (5728)	5.70±0.40	2.80±0.30	0.30	2.00±0.20	K	1,000
				2.50±0.30	M	500
				1.60±0.20	G	1,000



## FEATURES

- \* High voltage in a given case size.
- \* High stability and reliability.
- \* RoHS compliant.

## GENERAL ELECTRICAL DATA

Dielectric	NPO	X7R
Size	1808, 1812	
Capacitance*	3.9pF to 1000pF	150pF to 5600pF
Capacitance tolerance	J (±5%), K (±10%)	K (±10%), M (±20%)
Rated voltage (WVDC)	2000V, 3000V	
Rated voltage (WVAC)	250Vrms	
Q/ DF(Tan δ)	Cap<30pF: Q≥400+20C	Tan δ≤2.5%
Insulation resistance at Ur	≥10GΩ	
Dielectric withstanding strength	1500VAC	
Peak impulse voltage (X2)	2500V	
Operating temperature	-55 to +125°C	
Capacitance characteristic	±60ppm	±15%
Termination	Ni/Sn (lead-free termination)	
Certified number	TUV: R500021351,R50118359, R50195920, UL: E250427, E182369	
Test standard	EN 60384-14:2005, IEC 60384-14:2005, UL 60950:2000, UL 60384-14	

## EXPLANATION OF PART NUMBERS

S3	42	N	100	J	202	L	T
Series	Size (Inch (mm))	Dielectric	Capacitance	Tolerance	Rated voltage	Termination	Packaging
S3=X2/Y3	42=1808 (4520)	N=NPO	100=10x10 <sup>0</sup> =10pF	J=±5%	202=2000 VDC	L=Ag/Ni/Sn	T=7" reeled

\* Please refer to page 2 " How to order" for more information.

## CAPACITANCE RANGE

DIELECTRIC	NPO		
	SIZE	1808	1812
RATED VOLTAGE (VDC)	2000	3000	3000
3.9pF (3R9)		F	
4.7pF (4R7)		F	
5.0pF (5R0)		F	
5.6pF (5R6)		F	
6.8pF (6R8)		F	
8.2pF (8R2)		F	
10pF (100)	F	F	D
12pF (120)	F	F	D
15pF (150)	F	F	D
18pF (180)	F	F	D
22pF (220)	F	F	D
27pF (270)	F	F	D
33pF (330)	F	F	D
39pF (390)	G	G	D
47pF (470)	G	G	D
56pF (560)	G	G	D
68pF (680)	G	G	D
82pF (820)	G	G	D
100pF (101)	K	K	D
120pF (121)	K	K	D
150pF (151)	K	K	D
180pF (181)	K	K	D
220pF (221)	K	K	D
270pF (271)	K	K	D
330pF (331)	K		D
390pF (391)	K		D
470pF (471)	K		D
560pF (561)	K		D
680pF (681)	K		K
820pF (821)	K		K
1,000pF (102)	K		K

DIELECTRIC	X7R			
	SIZE	1808	1812	
RATED VOLTAGE (VDC)	2000	3000	2000	3000
150pF (151)	G			
180pF (181)	G			
220pF (221)	G			
270pF (271)	G		G	
330pF (331)	G	G	G	
390pF (391)	G	G	G	
470pF (471)	G	G	G	
560pF (561)	G	G	G	
680pF (681)	G	G	G	G
820pF (821)	G	G	G	G
1,000pF (102)	K	K	G	G
1,200pF (122)	K		G	
1,500pF (152)	K		K	
1,800pF (182)	K		K	
2,200pF (222)	K		M	
2,700pF (272)			M	
3,300pF (332)			M	
3,900pF (392)			M	
4,700pF (472)			M	
5,600pF (562)			M	

- The letter in cell is expressed the symbol of product thickness.
- For more information about products with special capacitance or other data, please contact WTC local representative.

## GENERAL ELECTRICAL DATA

Dielectric	NPO	X7R
Size	0402, 0603, 0805, 1206, 1210	
Capacitance range	0.5pF to 0.01uF	100pF to 1uF
Capacitance tolerance	Caps<5pF:B,C; 5pF<Cap<10pF:C,D; Cap≥10pF:F, G, J	J (±5%), K (±10%), M (±20%)
Rated voltage (WVDC)	10V, 16V, 25V, 50V, 100V, 250V, 500V, 630V	10V, 16V, 25V, 50V, 100V
Operating temperature	-55 to +125°C	
Capacitance characteristic	±30ppm/°C	±15%
Termination	Ni/Sn (lead-free termination)	

## EXPLANATION OF PART NUMBERS

MT	31	B	104	K	500	C	T
Series	Size (Inch (mm))	Dielectric	Capacitance	Tolerance	Rated voltage	Termination	Packaging
MT= Automotive (with AEC-Q200 qualification)	31=1206 (3216)	B=X7R	104=10x10 <sup>4</sup> =0.1uF	K=±10%	500=50 VDC	C=Cu/Ni/Sn	T=7" reeled

## CAPACITANCE RANGE

### NPO Dielectric

DIELECTRIC	NPO										
	SIZE	0402	0603	0805	1206	1210					
RATED VOLTAGE (VDC)	10,16,25,50	10,16,25,50,100	200	10,16,25,50	100	10,16,25,50	100	250	500	630	250
0.5pF (0R5)	N	S	S	A	A						
0.6pF (0R6)	N	S	S	A	A						
0.7pF (0R7)	N	S	S	A	A						
0.8pF (0R8)	N	S	S	A	A						
0.9pF (0R9)	N	S	S	A	A						
1.0pF (1R0)	N	S	S	A	A						
1.2pF (1R2)	N	S	S	A	A	B	B	B			
1.5pF (1R5)	N	S	S	A	A	B	B	B			
1.8pF (1R8)	N	S	S	A	A	B	B	B			
2.2pF (2R2)	N	S	S	A	A	B	B	B			
2.7pF (2R7)	N	S	S	A	A	B	B	B			
3.3pF (3R3)	N	S	S	A	A	B	B	B			
3.9pF (3R9)	N	S	S	A	A	B	B	B			
4.7pF (4R7)	N	S	S	A	A	B	B	B			
5.6pF (5R6)	N	S	S	A	A	B	B	B			
6.8pF (6R8)	N	S	S	A	A	B	B	B			
8.2pF (8R2)	N	S	S	A	A	B	B	B			
10pF (100)	N	S	S	A	A	B	B	B	C		
12pF (120)	N	S	S	A	A	B	B	B	C		
15pF (150)	N	S	S	A	A	B	B	B	C		
18pF (180)	N	S	S	A	A	B	B	B	C		
22pF (220)	N	S	S	A	A	B	B	B	C		
27pF (270)	N	S	S	A	A	B	B	B	C		
33pF (330)	N	S	S	A	A	B	B	B	C		
39pF (390)	N	S	S	A	A	B	B	B	C		
47pF (470)	N	S	S	A	A	B	B	B	C		
56pF (560)	N	S	S	A	A	B	B	B	C		
68pF (680)	N	S	S	A	A	B	B	B	C		
82pF (820)	N	S	S	A	A	B	B	B	C		
100pF (101)	N	S	S	A	A	B	B	B	C		
120pF (121)	N	S	S	A	A	B	B	B	C		
150pF (151)	N	S	S	A	A	B	B	B	C		
180pF (181)	N	S	S	A	A	B	B	B	C		
220pF (221)	N	S	S	A	A	B	B	B	C		
270pF (271)	N	S	S	A	A	B	B	B	C		
330pF (331)	N	S	S	A	A	B	B	B	C		
390pF (391)	N	S	S	A	A	B	B	B	C		
470pF (471)	N	S	S	A	A	B	B	B	C		
560pF (561)	N	S	S	A	A	B	B	B	C		
680pF (681)	N	S	S	A	A	B	B	B	C		
820pF (821)	N	S	S	A	A	B	B	B	C		
1,000pF (102)	N	S	S	A	A	B	B	B	C		
1,200pF (122)						B	B	B	C		
1,500pF (152)						B	B	B	C		
1,800pF (182)						B	B	B	C		
2,200pF (222)						B	B	B	C		
2,700pF (272)						B	B	B	C		
3,300pF (332)						B	B	B	C		
3,900pF (392)						B	B	B	C		
4,700pF (472)						B	B	B	C		
5,600pF (562)						B	B	B	C		
6,800pF (682)						B	B	B	C		
8,200pF (822)						B	B	B	C		
0.010uF (103)						D	D	D			

### X7R Dielectric

DIELECTRIC	X7R																		
	SIZE	0402	0603	0805				1206											
RATED VOLTAGE (VDC)	10	16	25	50	100	10	16	25	50	100	200	500	10	25	50	100	200	500	
100pF (101)	N	N	S	S	S	B	B	B	B	B	B	B	B					D	D
120pF (121)	N	N	S	S	S	B	B	B	B	B	B	B	B					D	D
150pF (151)	N	N	S	S	S	B	B	B	B	B	B	B	B	B	B	B	B	D	D
180pF (181)	N	N	S	S	S	B	B	B	B	B	B	B	B	B	B	B	B	D	D
220pF (221)	N	N	S	S	S	B	B	B	B	B	B	B	B	B	B	B	B	D	D
270pF (271)	N	N	S	S	S	B	B	B	B	B	B	B	B	B	B	B	B	D	D
330pF (331)	N	N	S	S	S	B	B	B	B	B	B	B	B	B	B	B	B	D	D
390pF (391)	N	N	S	S	S	B	B	B	B	B	B	B	B	B	B	B	B	D	D
470pF (471)	N	N	S	S	S	B	B	B	B	B	B	B	B	B	B	B	B	D	D
560pF (561)	N	N	S	S	S	B	B	B	B	B	B	B	B	B	B	B	B	D	D
680pF (681)	N	N	S	S	S	B	B	B	B	B	B	B	B	B	B	B	B	D	D
820pF (821)	N	N	S	S	S	B	B	B	B	B	B	B	B	B	B	B	B	D	D
1,000pF (102)	N	N	S	S	S	B	B	B	B	B	B	B	B	B	B	B	B	D	D
1,200pF (122)	N	N	S	S	S	B	B	B	B	B	B	B	B	B	B	B	B	D	D
1,500pF (152)	N	N	S	S	S	B	B	B	B	B	B	B	B	B	B	B	B	D	D
1,800pF (182)	N	N	S	S	S	B	B	B	B	B	B	B	B	B	B	B	B	D	D
2,200pF (222)	N	N	S	S	S	B	B	B	B	B	B	B	B	B	B	B	B	D	D
2,700pF (272)	N	N	S	S	S	B	B	B	B	B	B	B	B	B	B	B	B	D	D
3,300pF (332)	N	N	S	S	S	B	B	B	B	B	B	B	B	B	B	B	B	D	D
3,900pF (392)	N	N	S	S	S	B	B	B	B	B	B	B	B	B	B	B	B	D	D
4,700pF (472)	N	N	S	S	S	B	B	B	B	B	B	B	B	B	B	B	B	D	D
5,600pF (562)	N	N	S	S	S	B	B	B	B	B	B	B	B	B	B	B	B	D	D
6,800pF (682)	N	N	S	S	S	B	B	B	B	B	B	B	B	B	B	B	B	D	D
8,200pF (822)	N	N	S	S	S	B	B	B	B	B	B	B	B	B	B	B	B	D	D
0.010uF (103)	N	N	S	S	S	B	B	B	B	B	B	B	B	B	B	B	B	D	D
0.012uF (123)						S	S	B	B	B	D	B	B	B	B	B	B	D	D
0.015uF (153)						S	S	B	B	B	D	B	B	B	B	B	B	D	D
0.018uF (183)						S	S	B	B	B	D	B	B	B	B	B	B	D	D



## FEATURES

- \* A wide selection of sizes is available (0402 to 1812).
- \* High capacitance in given case size.
- \* Capacitor with lead-free termination (pure Tin).
- \* High reliability design with severe quality controls.

## GENERAL ELECTRICAL DATA

Dielectric	NPO	X7R	X5R
Size	0402, 0603, 0805, 1206, 1210, 1812		
Capacitance range*	0.5pF to 0.033μF	100pF to 2.2μF	0.056μF to 10μF
Capacitance tolerance**	J (±5%), K (±10%), M (±20%) Cap≤5pF: B (±0.1pF), C (±0.25pF) 5pF<Cap<10pF: C (±0.25pF), D (±0.5pF) Cap≥10pF: F (±1%), G (±2%), J (±5%)		
Rated voltage (WVDC)	16V, 25V, 50V, 100V	10V, 16V, 25V, 50V, 100V, 200V, 250V	6.3V, 10V, 16V, 25V
Operating temperature	-55 to +125°C		-55 to +85°C
Capacitance characteristic	±30ppm/°C		±15%
Termination	Ni/Sn (lead-free termination)		

## EXPLANATION OF PART NUMBERS

MG	31	B	104	K	500	C	T
Series MG= Automotive (without AEC-Q200 certification)	Size (Inch (mm)) 31=1206 (3216)	Dielectric B=X7R	Capacitance 104=10x10 <sup>4</sup> =0.1μF	Tolerance K=±10%	Rated voltage 500=50 VDC	Termination C=Cu/Ni/Sn	Packaging T=7" reeled

\* Please refer to page 2 "How to order" for more information.

## CAPACITANCE RANGE

### X5R Dielectric

Dielectric	X5R																			
	Size		0402				0603				0805				1206		1210			
Rated Voltage(VDC)	6.3	10	16	6.3	10	16	25	6.3	10	16	25	6.3	10	16	25	10	16			
0.056μF (563)		N																		
0.068μF (683)		N																		
0.082μF (823)		N																		
0.10μF (104)		N	N																	
0.15μF (154)		N	N																	
0.22μF (224)	N	N	N				X													
0.27μF (274)	N	N					X	X	X											
0.33μF (334)	N	N					X	X	X											
0.39μF (394)	N						X	X	X											
0.47μF (474)	N						X	X	X											
0.68μF (684)	N						X	X	X											
0.82μF (824)	N				X		X	X	X											
1.0μF (105)				X	X	X	X													
1.5μF (155)										I	I					J	J	P	K	K
2.2μF (225)										I	I	I	I			J	J	P	K	K
3.3μF (335)										I	I	I	I	P	P	P	P	P	K	K
4.7μF (475)										I	I	I	I	P	P	P	P	P	K	K
6.8μF (685)														P	P					
10μF (106)														P	P					

- The letter in cell is expressed the symbol of product thickness.
- For more information about products with special capacitance or other data, please contact WTC local representative.

## NPO Dielectric

Dielectric	Size	NPO														
		0402		0603		0805			1206		1210		1812			
Rated Voltage (VDC)		10,16, 25,50, 100	10,16, 25,50, 100	10,16, 25,50	100	200	250	500, 630	10,16, 25,50	100	10,16	25,50	100	10,16, 25,50	100	
0.1pF (0R1)																
0.2pF (0R2)																
0.3pF (0R3)																
0.4pF (0R4)																
0.5pF (0R5)	N	S	A	A	A	A	A	A								
0.6pF (0R6)	N	S	A	A	A	A	A	A								
0.7pF (0R7)	N	S	A	A	A	A	A	A								
0.8pF (0R8)	N	S	A	A	A	A	A	A								
0.9pF (0R9)	N	S	A	A	A	A	A	A								
1.0pF (1R0)	N	S	A	A	A	A	A	A								
1.2pF (1R2)	N	S	A	A	A	A	A	A								
1.5pF (1R5)	N	S	A	A	A	A	A	A	B	B						
1.8pF (1R8)	N	S	A	A	A	A	A	A	B	B						
2.2pF (2R2)	N	S	A	A	A	A	A	A	B	B						
2.7pF (2R7)	N	S	A	A	A	A	A	A	B	B						
3.3pF (3R3)	N	S	A	A	A	A	A	A	B	B						
3.9pF (3R9)	N	S	A	A	A	A	A	A	B	B						
4.7pF (4R7)	N	S	A	A	A	A	A	A	B	B						
5.6pF (5R6)	N	S	A	A	A	A	A	A	B	B						
6.8pF (6R8)	N	S	A	A	A	A	A	A	B	B						
8.2pF (8R2)	N	S	A	A	A	A	A	A	B	B						
10pF (100)	N	S	A	A	A	A	A	A	B	B	C	C	C	C	D	D
12pF (120)	N	S	A	A	A	A	A	A	B	B	C	C	C	C	D	D
15pF (150)	N	S	A	A	A	A	A	A	B	B	C	C	C	C	D	D
18pF (180)	N	S	A	A	A	A	A	A	B	B	C	C	C	C	D	D
22pF (220)	N	S	A	A	A	A	A	A	B	B	C	C	C	C	D	D
27pF (270)	N	S	A	A	A	A	A	A	B	B	C	C	C	C	D	D
33pF (330)	N	S	A	A	A	A	A	A	B	B	C	C	C	C	D	D
39pF (390)	N	S	A	A	A	A	A	A	B	B	C	C	C	C	D	D
47pF (470)	N	S	A	A	A	A	A	A	B	B	C	C	C	C	D	D
56pF (560)	N	S	A	A	A	A	A	A	B	B	C	C	C	C	D	D
68pF (680)	N	S	A	A	A	A	A	A	B	B	C	C	C	C	D	D
82pF (820)	N	S	A	A	A	A	A	B	B	B	C	C	C	C	D	D
100pF (101)	N	S	A	A	A	A	B	B	B	B	C	C	C	C	D	D
120pF (121)	N	S	A	A	A	A	B	D	B	B	C	C	C	C	D	D
150pF (151)	N	S	A	A	A	B	D	D	D	B	B	C	C	C	D	D
180pF (181)	N	S	A	A	A	B	D	D	D	B	B	C	C	C	D	D
220pF (221)	N	S	A	A	A	D	D	D	D	B	B	C	C	C	D	D
270pF (271)		S	A	A	A	D	D	D	D	B	B	C	C	C	D	D
330pF (331)		S	A	A	A	D	D	D	D	B	B	C	C	C	D	D
390pF (391)		S	B	B	D	D	D	D	D	B	B	C	C	C	D	D
470pF (471)		S	B	B	D	D	D	D	D	B	B	C	C	C	D	D
560pF (561)		S	B	B	D	D	D	D	D	B	B	C	C	C	D	D
680pF (681)		S	B	B	D	D	D	D	D	B	B	C	C	C	D	D
820pF (821)		S	B	B	D	D	D	D	D	B	B	C	C	C	D	D
1,000pF (102)		S	B	B	D	D	D	D	D	B	B	C	C	C	D	D
1,200pF (122)			B	B	D	D	D	D	D	B	B	C	C	C	D	D
1,500pF (152)			B	B	D	D	D	D	D	B	B	C	C	C	D	D
1,800pF (182)			B	B	D	D	D	D	D	B	B	C	C	C	D	D
2,200pF (222)			B	B	D	D	D	D	D	B	B	C	C	C	D	D
2,700pF (272)			D	D						B	B	C	C	C	D	D
3,300pF (332)			D							B	B	C	C	C	D	D
3,900pF (392)			D							B	B	C	C	C	D	D
4,700pF (472)			D							B	B	C	C	C	D	D
5,600pF (562)			D							B	B	C	C	C	D	D
6,800pF (682)			D							C		C	C	C	D	D
8,200pF (822)			D							D		C	C	C	D	D
0.010uF (103)			D									C	C	C	D	D
0.012uF (123)												C	D	D	D	D
0.015uF (153)												C	D	D	D	D
0.018uF (183)															D	D
0.022uF (223)															D	D
0.027uF (273)															D	D
0.033uF (333)															D	D

- The letter in cell is expressed the symbol of product thickness.
- The letter in cell with "A" mark is expressed product with Ag/Ni/Sn terminations.
- For more information about products with special capacitance or other data, please contact WTC local representative.



## X7R Dielectric

Dielectric	X7R																									
	Size		0402			0603			0805				1206				1210				1812					
Rated Voltage (VDC)	10, 16	25	50	6.3, 10, 16	25	50	100	10, 16	25	50	100	200, 250	10, 16	25	50	100	200, 250	10, 16	25	50	100	200, 250	10, 16, 25	50	100	200, 250
100pF (101)	N	N	N	S	S	S	S	B	B	B	B	B														
120pF (121)	N	N	N	S	S	S	S	B	B	B	B	B														
150pF (151)	N	N	N	S	S	S	S	B	B	B	B	B	B	B	B	B	B									
180pF (181)	N	N	N	S	S	S	S	B	B	B	B	B	B	B	B	B	B									
220pF (221)	N	N	N	S	S	S	S	B	B	B	B	B	B	B	B	B	B									
270pF (271)	N	N	N	S	S	S	S	B	B	B	B	B	B	B	B	B	B									
330pF (331)	N	N	N	S	S	S	S	B	B	B	B	B	B	B	B	B	B									
390pF (391)	N	N	N	S	S	S	S	B	B	B	B	B	B	B	B	B	B									
470pF (471)	N	N	N	S	S	S	S	B	B	B	B	B	B	B	B	B	B									
560pF (561)	N	N	N	S	S	S	S	B	B	B	B	B	B	B	B	B	B									
680pF (681)	N	N	N	S	S	S	S	B	B	B	B	B	B	B	B	B	B									
820pF (821)	N	N	N	S	S	S	S	B	B	B	B	B	B	B	B	B	B									
1,000pF (102)	N	N	N	S	S	S	S	B	B	B	B	B	B	B	B	B	B	C	C	C	C	C	D	D	D	D
1,200pF (122)	N	N	N	S	S	S	S	B	B	B	B	B	B	B	B	B	B	C	C	C	C	C	D	D	D	D
1,500pF (152)	N	N	N	S	S	S	S	B	B	B	B	B	B	B	B	B	B	C	C	C	C	C	D	D	D	D
1,800pF (182)	N	N	N	S	S	S	S	B	B	B	B	B	B	B	B	B	B	C	C	C	C	C	D	D	D	D
2,200pF (222)	N	N	N	S	S	S	S	B	B	B	B	B	B	B	B	B	B	C	C	C	C	C	D	D	D	D
2,700pF (272)	N	N	N	S	S	S	S	B	B	B	B	B	B	B	B	B	B	C	C	C	C	C	D	D	D	D
3,300pF (332)	N	N	N	S	S	S	S	B	B	B	B	B	B	B	B	B	B	C	C	C	C	C	D	D	D	D
3,900pF (392)	N	N	N	S	S	S	S	B	B	B	B	B	B	B	B	B	B	C	C	C	C	C	D	D	D	D
4,700pF (472)	N	N	N	S	S	S	S	B	B	B	B	B	B	B	B	B	B	C	C	C	C	C	D	D	D	D
5,600pF (562)	N	N	N	S	S	S	S	B	B	B	B	B	B	B	B	B	B	C	C	C	C	C	D	D	D	D
6,800pF (682)	N	N	N	S	S	S	S	B	B	B	B	B	B	B	B	B	B	C	C	C	C	C	D	D	D	D
8,200pF (822)	N	N	N	S	S	S	S	B	B	B	B	B	B	B	B	B	B	C	C	C	C	C	D	D	D	D
0.010uF (103)	N	N	N	S	S	S	S	B	B	B	B	B	B	B	B	B	B	C	C	C	C	C	D	D	D	D
0.012uF (123)	N	N		S	S	S		B	B	B	B	B	B	B	B	B	B	C	C	C	C	C	D	D	D	D
0.015uF (153)	N	N		S	S	S		B	B	B	B	B	B	B	B	B	B	C	C	C	C	C	D	D	D	D
0.018uF (183)	N	N		S	S	S		B	B	B	B	B	B	B	B	B	B	C	C	C	C	C	D	D	D	D
0.022uF (223)	N	N		S	S	S		B	B	B	B	B	B	B	B	B	B	C	C	C	C	C	D	D	D	D
0.027uF (273)	N	N		S	S	S		B	B	B	B	B	B	B	B	B	B	C	C	C	C	C	D	D	D	D
0.033uF (333)	N	N		S	S	X		B	B	B	B	B	B	B	B	B	B	G	C	C	C	C	D	D	D	D
0.039uF (393)	N	N		S	S	X		B	B	B	B	B	B	B	B	B	B	G	C	C	C	C	D	D	D	D
0.047uF (473)	N	N		S	S	X		B	B	B	B	B	B	B	B	B	B	G	C	C	C	C	D	D	D	D
0.056uF (563)	N			S	S	X		B	B	B	B	B	B	B	B	B	B	G	C	C	C	C	D	D	D	D
0.068uF (683)	N			S	S	X		B	B	B	B	B	B	B	B	B	B	G	C	C	C	C	D	D	D	D
0.082uF (823)	N			S	S	X		B	B	B	B	B	B	B	B	B	B	G	C	C	C	C	D	D	D	D
0.10uF (104)	N	N		S	S	X		B	B	B	B	B	B	B	B	B	B	G	C	C	C	C	D	D	D	D
0.12uF (124)				S	X			D	D	D			B	B	B	B	D	C	C	C	C	G	D	D	D	D
0.15uF (154)				S	X			D	D	D			C	C	C	G		C	C	C	D	M	D	D	D	K
0.18uF (184)				S	X			D	D	D			C	C	C	G		C	C	C	D	M	D	D	D	K
0.22uF (224)				S	X			D	D	D			C	C	C	G		C	C	C	D	M	D	D	D	K
0.27uF (274)				X				D	D				C	C	D			C	C	C	G	M	D	D	D	K
0.33uF (334)				X				D	D				C	C	D			C	C	D	G	M	D	D	D	K
0.39uF (394)				X				D	D				C	J	P			C	C	D	M	M	D	D	D	K
0.47uF (474)				X				D	D				J	J	P			C	C	D	M	M	D	D	K	K
0.56uF (564)								D	D				J	J	P			D	D	D	M		D	D	K	
0.68uF (684)								D	D				J	J	P			D	D	D	K		D	K	K	
0.82uF (824)								D	D				J	J	P			D	D	D	K		D	K	K	
1.0uF (105)								D	D				J	J	P			D	D	D	K		D	K	K	
1.5uF (155)													J	P				K	G						K	
2.2uF (225)													J	P				K	G						M	

1. The letter in cell is expressed the symbol of product thickness.  
 2. For more information about products with special capacitance or other data, please contact WTC local representative.

## FEATURES

- \* High density mounting due to mounting space saving.
- \* Mounting cost saving.
- \* Increased throughput.

## GENERAL ELECTRICAL DATA

Dielectric	NPO	X7R
Size	4x0402	4x0402
Capacitance range*	10pF to 220pF	1000pF to 0.1uF
Capacitance tolerance**	J (±5%), K (±10%)	K (±10%), M (±20%)
Rated voltage (WVDC)	50V	10V, 16V, 25V
Insulation resistance at Ur	≥10GΩ or RxC≥500ΩxF whichever is less	
Operating temperature	-55 to +125°C	
Capacitance characteristic	±30ppm	±15%
Termination	Ni/Sn (lead-free termination)	

## EXPLANATION OF PART NUMBERS

MY	24	N	102	J	500	C	T
Series MY= Automotive Capacitor array (with AEC-Q200 qualification)	Size (Inch (mm)) 24=4x0402	Dielectric N=NP0 (C0G) B=X7R	Capacitance 102=10x10 <sup>2</sup> =1000pFuF	Tolerance J=±5%	Rated voltage 500=50 VDC	Termination C=Cu/Ni/Sn	Packaging T=7" reeled G=13" reeled

\* Please refer to page 2 "How to order" for more information.

## CAPACITANCE RANGE

Size	4 x 0402			
	Dielectric	NPO	X7R	
Rated Voltage(VDC)	50	10	16	25
10pF (100)	T			
15pF (150)	T			
22pF (220)	T			
33pF (330)	T			
47pF (470)	T			
68pF (680)	T			
100pF (101)	T			
150pF (151)	T			
180pF (181)	T			
220pF (221)	T			
270pF (271)				
330pF (331)				
470pF (471)				
6,80pF (681)				
1,000pF (102)		T	T	T
1,500pF (152)		T	T	T
2,200pF (222)		T	T	T
3,300pF (332)		T	T	T
4,700pF (472)		T	T	T
6,800pF (682)		T	T	T
0.010uF (103)		T	T	T
0.015uF (153)		T	T	T
0.022uF (223)		T	T	T
0.033uF (333)		T	T	T
0.047uF (473)		T	T	T
0.068uF (683)		T	T	T
0.10uF (104)		T	T	T

1. The letter in cell is expressed the symbol of product thickness.  
 2. For more information about products with special capacitance or other data, please contact WTC local representative.



# Appendix I : Reliability Test Conditions and Requirements

\* About Reliability Test Conditions and Requirements, please refer to Walsin MLCC approval sheet for more detail.

No	Item	Test Condition	Requirements																																																			
1.	Visual and Mechanical	---	* No remarkable defect. * Dimensions to conform to individual specification sheet.																																																			
2.	Capacitance	Class I: NP0 Cap≤1000pF 1.0±0.2Vrms, 1MHz±10% Cap>1000pF 1.0±0.2Vrms, 1KHz±10% **	* Shall not exceed the limits given in the detailed spec.																																																			
3.	Q/ D.F. (Dissipation Factor)	Class II * : X7R, X7E, X6S, X5R, Y5V Cap≤10μF, 1.0±0.2Vrms, 1kHz±10% ** Cap>10μF, 0.5±0.2Vrms, 120Hz±20%  ** Test condition: 0.5±0.2Vrms, 1KHz±10% X7R: 0805=106(6.3V&10V) X5R: 01R5=103, 0201=224 (6.3V,10V), 0402=475 (6.3V), 0402=225(10V), 0603=106 (6.3V,10V), TT18X=475(10V) , TT15X series X6S:0201=104 (6.3V),0402=225 (6.3V), 0603=106 (6.3V),  * Preconditioning for Class II MLCC: Perform a heat treatment at 150±10°C for 1 hour, then leave in ambient condition for 24±2 hours before measurement.	NP0: Cap≥30pF, Q≥1000; Cap<30pF, Q≥400+20C X7R,, X6S, X5R: <table border="1"> <thead> <tr> <th>Rated vol.</th> <th>D.F. ≤</th> <th>Exception of D.F. ≤</th> </tr> </thead> <tbody> <tr> <td>≥100V</td> <td>≤2.5%</td> <td>≤3% 1206±0.47μF ≤5% 0805±0.1μF, 0603±0.068μF; 1206&gt;1μF; TT series</td> </tr> <tr> <td>50V</td> <td>≤2.5%</td> <td>≤3% 0201(50V); 0603±0.047μF; 0805±0.18μF; 1206±0.47μF ≤5% 1210±4.7μF</td> </tr> <tr> <td>35V</td> <td>≤3.5%</td> <td>≤10% 0402±0.1μF; 0603±0.1μF; 0603±1μF; 0805±1μF; 1206±2.2μF; 1210±10μF; TT series ≤10% 0603±1μF; 0805±2.2μF; 1210±10μF</td> </tr> <tr> <td>25V</td> <td>≤3.5%</td> <td>≤5% 0201±0.01μF; 0805±1μF; 1210±10μF ≤7% 0603±0.33μF; 1206±4.7μF ≤10% 0402±0.10μF; 0603±0.47μF; 0805±2.2μF; 1206±6.8μF; 1210±22μF; TT series ≤12.5% 0402±1μF</td> </tr> <tr> <td>16V</td> <td>≤3.5%</td> <td>≤5% 0201±0.01μF; 0402±0.033μF; 0603±0.15μF; 0805±0.68μF; 1206±2.2μF; 1210±4.7μF ≤10% 0201±0.1μF; 0402±0.22μF; 0603±0.68μF; 0805±2.2μF; 1206±4.7μF; 1210±22μF; TT series</td> </tr> <tr> <td>10V</td> <td>≤5%</td> <td>≤10% 0201±0.012μF; 0402±0.33μF(0402/X7R±0.22μF); 0603±0.33μF; 0805±2.2μF; 1206±2.2μF; 1210±22μF; TT series ≤15% 0201±0.1μF; 0402±1μF</td> </tr> <tr> <td>6.3V</td> <td>≤10%</td> <td>≤15% 0201±0.1μF; 0402±1μF; 0603±10μF; 0805±4.7μF; 1206±4.7μF; 1210±100μF; TT series ≤20% 0402±2.2μF</td> </tr> <tr> <td>4V</td> <td>≤15%</td> <td>---</td> </tr> </tbody> </table> X7R/X7E, LD series : 100V: DF≤1.4%; ≤200V:DF≤1.0% Y5V: <table border="1"> <thead> <tr> <th>Rated vol.</th> <th>D.F. ≤</th> <th>Exception of D.F. ≤</th> </tr> </thead> <tbody> <tr> <td>≥50V</td> <td>≤5%</td> <td>≤7% 0603±0.1μF; 0805±0.47μF; 1206±4.7μF; TT series &amp; Cap≥1μF</td> </tr> <tr> <td>35V</td> <td>≤7%</td> <td>---</td> </tr> <tr> <td>25V</td> <td>≤5%</td> <td>≤7% 0402±0.047μF; 0603±0.1μF; 0805±0.33μF; 1206±4.7μF; 1210±4.7μF ≤9% 0402±0.068μF; 0603±0.47μF; 1206±4.7μF; 1210±22μF; TT series &amp; Cap≥1μF</td> </tr> <tr> <td>16V (C&lt;1.0μF)</td> <td>≤7%</td> <td>≤9% 0402±0.068μF; 0603±0.68μF ≤12.5% 0402±0.22μF</td> </tr> <tr> <td>16V (C≥1.0μF)</td> <td>≤9%</td> <td>≤12.5% 0603±2.2μF; 0805±3.3μF; 1206±10μF; 1210±22μF; 1812±47μF; TT series &amp; Cap≥1μF</td> </tr> <tr> <td>10V</td> <td>≤12.5%</td> <td>≤20% 0402±0.47μF</td> </tr> <tr> <td>6.3V</td> <td>≤20%</td> <td>---</td> </tr> </tbody> </table>	Rated vol.	D.F. ≤	Exception of D.F. ≤	≥100V	≤2.5%	≤3% 1206±0.47μF ≤5% 0805±0.1μF, 0603±0.068μF; 1206>1μF; TT series	50V	≤2.5%	≤3% 0201(50V); 0603±0.047μF; 0805±0.18μF; 1206±0.47μF ≤5% 1210±4.7μF	35V	≤3.5%	≤10% 0402±0.1μF; 0603±0.1μF; 0603±1μF; 0805±1μF; 1206±2.2μF; 1210±10μF; TT series ≤10% 0603±1μF; 0805±2.2μF; 1210±10μF	25V	≤3.5%	≤5% 0201±0.01μF; 0805±1μF; 1210±10μF ≤7% 0603±0.33μF; 1206±4.7μF ≤10% 0402±0.10μF; 0603±0.47μF; 0805±2.2μF; 1206±6.8μF; 1210±22μF; TT series ≤12.5% 0402±1μF	16V	≤3.5%	≤5% 0201±0.01μF; 0402±0.033μF; 0603±0.15μF; 0805±0.68μF; 1206±2.2μF; 1210±4.7μF ≤10% 0201±0.1μF; 0402±0.22μF; 0603±0.68μF; 0805±2.2μF; 1206±4.7μF; 1210±22μF; TT series	10V	≤5%	≤10% 0201±0.012μF; 0402±0.33μF(0402/X7R±0.22μF); 0603±0.33μF; 0805±2.2μF; 1206±2.2μF; 1210±22μF; TT series ≤15% 0201±0.1μF; 0402±1μF	6.3V	≤10%	≤15% 0201±0.1μF; 0402±1μF; 0603±10μF; 0805±4.7μF; 1206±4.7μF; 1210±100μF; TT series ≤20% 0402±2.2μF	4V	≤15%	---	Rated vol.	D.F. ≤	Exception of D.F. ≤	≥50V	≤5%	≤7% 0603±0.1μF; 0805±0.47μF; 1206±4.7μF; TT series & Cap≥1μF	35V	≤7%	---	25V	≤5%	≤7% 0402±0.047μF; 0603±0.1μF; 0805±0.33μF; 1206±4.7μF; 1210±4.7μF ≤9% 0402±0.068μF; 0603±0.47μF; 1206±4.7μF; 1210±22μF; TT series & Cap≥1μF	16V (C<1.0μF)	≤7%	≤9% 0402±0.068μF; 0603±0.68μF ≤12.5% 0402±0.22μF	16V (C≥1.0μF)	≤9%	≤12.5% 0603±2.2μF; 0805±3.3μF; 1206±10μF; 1210±22μF; 1812±47μF; TT series & Cap≥1μF	10V	≤12.5%	≤20% 0402±0.47μF	6.3V	≤20%	---
Rated vol.	D.F. ≤	Exception of D.F. ≤																																																				
≥100V	≤2.5%	≤3% 1206±0.47μF ≤5% 0805±0.1μF, 0603±0.068μF; 1206>1μF; TT series																																																				
50V	≤2.5%	≤3% 0201(50V); 0603±0.047μF; 0805±0.18μF; 1206±0.47μF ≤5% 1210±4.7μF																																																				
35V	≤3.5%	≤10% 0402±0.1μF; 0603±0.1μF; 0603±1μF; 0805±1μF; 1206±2.2μF; 1210±10μF; TT series ≤10% 0603±1μF; 0805±2.2μF; 1210±10μF																																																				
25V	≤3.5%	≤5% 0201±0.01μF; 0805±1μF; 1210±10μF ≤7% 0603±0.33μF; 1206±4.7μF ≤10% 0402±0.10μF; 0603±0.47μF; 0805±2.2μF; 1206±6.8μF; 1210±22μF; TT series ≤12.5% 0402±1μF																																																				
16V	≤3.5%	≤5% 0201±0.01μF; 0402±0.033μF; 0603±0.15μF; 0805±0.68μF; 1206±2.2μF; 1210±4.7μF ≤10% 0201±0.1μF; 0402±0.22μF; 0603±0.68μF; 0805±2.2μF; 1206±4.7μF; 1210±22μF; TT series																																																				
10V	≤5%	≤10% 0201±0.012μF; 0402±0.33μF(0402/X7R±0.22μF); 0603±0.33μF; 0805±2.2μF; 1206±2.2μF; 1210±22μF; TT series ≤15% 0201±0.1μF; 0402±1μF																																																				
6.3V	≤10%	≤15% 0201±0.1μF; 0402±1μF; 0603±10μF; 0805±4.7μF; 1206±4.7μF; 1210±100μF; TT series ≤20% 0402±2.2μF																																																				
4V	≤15%	---																																																				
Rated vol.	D.F. ≤	Exception of D.F. ≤																																																				
≥50V	≤5%	≤7% 0603±0.1μF; 0805±0.47μF; 1206±4.7μF; TT series & Cap≥1μF																																																				
35V	≤7%	---																																																				
25V	≤5%	≤7% 0402±0.047μF; 0603±0.1μF; 0805±0.33μF; 1206±4.7μF; 1210±4.7μF ≤9% 0402±0.068μF; 0603±0.47μF; 1206±4.7μF; 1210±22μF; TT series & Cap≥1μF																																																				
16V (C<1.0μF)	≤7%	≤9% 0402±0.068μF; 0603±0.68μF ≤12.5% 0402±0.22μF																																																				
16V (C≥1.0μF)	≤9%	≤12.5% 0603±2.2μF; 0805±3.3μF; 1206±10μF; 1210±22μF; 1812±47μF; TT series & Cap≥1μF																																																				
10V	≤12.5%	≤20% 0402±0.47μF																																																				
6.3V	≤20%	---																																																				
4a.	Dielectric Strength	*To apply voltage(≤100V) 250%. *Duration: 1 to 5 sec. *Charge & discharge current less than 50mA.  *To apply voltage: 200V ~300V & LD series ≥2 times V DC 500V ~ 999V ≥1.5 times V DC 1000V ~ 3000V ≥1.2 times V DC *Cut-off, set at 10mA *TEST= 15 sec. *RAMP=0	*No evidence of damage or flash over during test.																																																			
4b.	Dielectric Strength (for X1/Y2 & X2/Y3)	* To apply 1500 VAC voltage. * Duration: 60 sec.	* No evidence of damage or flash over during test.																																																			
5.	Insulation Resistance	To apply rated voltage for max. 120 sec.	10GΩ or RxC≥500Ω-F whichever is smaller. Class II (X7R, X7E, X5R, Y5V) <table border="1"> <thead> <tr> <th>Rated voltage</th> <th>Insulation Resistance</th> </tr> </thead> <tbody> <tr> <td>100V: X7R</td> <td rowspan="6">10GΩ or RxC≥100 Ω-F whichever is smaller.</td> </tr> <tr> <td>50V:0603±1μF;0805±1μF;1206±2.2μF;1210±4.7μF</td> </tr> <tr> <td>35V:0805±2.2μF;1210±10μF</td> </tr> <tr> <td>25V:0402±1μF;0603±2.2μF;0805±2.2μF;1206±10μF;1210±10μF</td> </tr> <tr> <td>16V:0201±0.1μF;0402±0.22μF;0603±1μF;0805±2.2μF;1206±10μF;1210±47μF</td> </tr> <tr> <td>10V:0201±47nF;0402±0.47μF;0603±0.47μF; 0805±2.2μF; 1206±4.7μF;1210±47μF</td> </tr> <tr> <td>6.3V : 4V ; TT series</td> <td rowspan="3">RxC≥50 Ω-F</td> </tr> <tr> <td>All X6S items</td> </tr> <tr> <td>50V: 0402±0.1μF; 0603±2.2μF; 0805±10μF; 1206±10μF / 35V: 0603±1μF / 25V: 0201±0.1μF; 0402±0.22μF; 0603±10μF; 1206±22μF / 16V: 0603±10μF / 4V: 0603±22μF; 0805±47μF</td> </tr> <tr> <td>10V: 0201±0.1μF; 0603±10μF; 0805±47μF / 6.3V: 0201±0.1μF; 1206±10μF</td> <td></td> </tr> </tbody> </table> Rated Voltage: 200V ~ 630V To apply rated voltage (500V max.) for 60 sec. Rated Voltage: >630V To apply 500V for 60sec.	Rated voltage	Insulation Resistance	100V: X7R	10GΩ or RxC≥100 Ω-F whichever is smaller.	50V:0603±1μF;0805±1μF;1206±2.2μF;1210±4.7μF	35V:0805±2.2μF;1210±10μF	25V:0402±1μF;0603±2.2μF;0805±2.2μF;1206±10μF;1210±10μF	16V:0201±0.1μF;0402±0.22μF;0603±1μF;0805±2.2μF;1206±10μF;1210±47μF	10V:0201±47nF;0402±0.47μF;0603±0.47μF; 0805±2.2μF; 1206±4.7μF;1210±47μF	6.3V : 4V ; TT series	RxC≥50 Ω-F	All X6S items	50V: 0402±0.1μF; 0603±2.2μF; 0805±10μF; 1206±10μF / 35V: 0603±1μF / 25V: 0201±0.1μF; 0402±0.22μF; 0603±10μF; 1206±22μF / 16V: 0603±10μF / 4V: 0603±22μF; 0805±47μF	10V: 0201±0.1μF; 0603±10μF; 0805±47μF / 6.3V: 0201±0.1μF; 1206±10μF																																					
Rated voltage	Insulation Resistance																																																					
100V: X7R	10GΩ or RxC≥100 Ω-F whichever is smaller.																																																					
50V:0603±1μF;0805±1μF;1206±2.2μF;1210±4.7μF																																																						
35V:0805±2.2μF;1210±10μF																																																						
25V:0402±1μF;0603±2.2μF;0805±2.2μF;1206±10μF;1210±10μF																																																						
16V:0201±0.1μF;0402±0.22μF;0603±1μF;0805±2.2μF;1206±10μF;1210±47μF																																																						
10V:0201±47nF;0402±0.47μF;0603±0.47μF; 0805±2.2μF; 1206±4.7μF;1210±47μF																																																						
6.3V : 4V ; TT series	RxC≥50 Ω-F																																																					
All X6S items																																																						
50V: 0402±0.1μF; 0603±2.2μF; 0805±10μF; 1206±10μF / 35V: 0603±1μF / 25V: 0201±0.1μF; 0402±0.22μF; 0603±10μF; 1206±22μF / 16V: 0603±10μF / 4V: 0603±22μF; 0805±47μF																																																						
10V: 0201±0.1μF; 0603±10μF; 0805±47μF / 6.3V: 0201±0.1μF; 1206±10μF																																																						
6.	Temperature Coefficient	With no electrical load. <table border="1"> <thead> <tr> <th>T.C.</th> <th>Operating Temp</th> </tr> </thead> <tbody> <tr> <td>NP0 (C0G)</td> <td>-55~125°C at 25°C</td> </tr> <tr> <td>NP0 (COH)</td> <td>-55~125°C at 25°C</td> </tr> <tr> <td>NP0 (COJ)</td> <td>-55~125°C at 25°C</td> </tr> <tr> <td>X7R</td> <td>-55~125°C at 25°C</td> </tr> <tr> <td>X7E</td> <td>-55~125°C at 25°C</td> </tr> <tr> <td>X6S</td> <td>-55~105°C at 25°C</td> </tr> <tr> <td>X5R</td> <td>-55~ 85°C at 25°C</td> </tr> <tr> <td>Y5V</td> <td>-25~ 85°C at 20°C</td> </tr> </tbody> </table>	T.C.	Operating Temp	NP0 (C0G)	-55~125°C at 25°C	NP0 (COH)	-55~125°C at 25°C	NP0 (COJ)	-55~125°C at 25°C	X7R	-55~125°C at 25°C	X7E	-55~125°C at 25°C	X6S	-55~105°C at 25°C	X5R	-55~ 85°C at 25°C	Y5V	-25~ 85°C at 20°C	<table border="1"> <thead> <tr> <th>T.C.</th> <th>Capacitance Change</th> </tr> </thead> <tbody> <tr> <td>NP0 (C0G)</td> <td>Within ±30ppm/°C</td> </tr> <tr> <td>NP0 (COH)</td> <td>Within ±60ppm/°C</td> </tr> <tr> <td>NP0 (COJ)</td> <td>Within ±120ppm/°C</td> </tr> <tr> <td>X7R</td> <td>Within ±15%</td> </tr> <tr> <td>X7E</td> <td>Within ±4.7%</td> </tr> <tr> <td>X6S</td> <td>Within ±22%</td> </tr> <tr> <td>X5R</td> <td>Within ±15%</td> </tr> <tr> <td>Y5V</td> <td>Within +30%/ -80%</td> </tr> </tbody> </table>	T.C.	Capacitance Change	NP0 (C0G)	Within ±30ppm/°C	NP0 (COH)	Within ±60ppm/°C	NP0 (COJ)	Within ±120ppm/°C	X7R	Within ±15%	X7E	Within ±4.7%	X6S	Within ±22%	X5R	Within ±15%	Y5V	Within +30%/ -80%															
T.C.	Operating Temp																																																					
NP0 (C0G)	-55~125°C at 25°C																																																					
NP0 (COH)	-55~125°C at 25°C																																																					
NP0 (COJ)	-55~125°C at 25°C																																																					
X7R	-55~125°C at 25°C																																																					
X7E	-55~125°C at 25°C																																																					
X6S	-55~105°C at 25°C																																																					
X5R	-55~ 85°C at 25°C																																																					
Y5V	-25~ 85°C at 20°C																																																					
T.C.	Capacitance Change																																																					
NP0 (C0G)	Within ±30ppm/°C																																																					
NP0 (COH)	Within ±60ppm/°C																																																					
NP0 (COJ)	Within ±120ppm/°C																																																					
X7R	Within ±15%																																																					
X7E	Within ±4.7%																																																					
X6S	Within ±22%																																																					
X5R	Within ±15%																																																					
Y5V	Within +30%/ -80%																																																					
7.	Adhesive Strength of Termination	*Pressurizing force: 01005:1N, 0201:2N, 0402 & 0603: 5N >0603: 10N *Test time:10 ±1 sec	* No remarkable damage or removal of the terminations.																																																			

# Appendix I : Reliability Test Conditions and Requirements

No	Item	Test Condition	Requirements																																																														
8.	Vibration Resistance	* Vibration frequency: 10~55 Hz/min. * Total amplitude: 1.5mm * Test time: 6 hrs. (Two hrs each in three mutually perpendicular directions.) * Measurement to be made after keeping at room temp. for 24±2 hrs.	* No remarkable defect. * Dimensions to conform to individual specification sheet.																																																														
9.	Solderability	* Solder temperature: 235±5°C * Dipping time: 2±0.5 sec.	95% min. coverage of all metalized area.																																																														
10.	Bending Test	*The middle part of substrate shall be pressurized by means of the pressurizing rod at a rate of about 1 mm per second until the deflection becomes 1 mm / SH series: 5 mm** & 3 mm*** and then the pressure shall be maintained for 5±1 sec. *Measurement to be made after keeping at room temp. for 24±2 hrs. (** Thickness >1.0mm; *** Thickness≤1.0mm)	* No remarkable damage. * Cap change: NP0: within ±5% or 0.5pF whichever is larger X7R, X7E, X6S, X5R: within ±12.5% , Y5V: within ±30% (This capacitance change means the change of capacitance under specified flexure of substrate from the capacitance measured before the test.)																																																														
11.	Resistance to Soldering Heat	* Solder temperature: 260±5°C * Dipping time: 10±1 sec * Preheating: 120 to 150°C for 1 minute before immerse the capacitor in a eutectic solder. * Before initial measurement (Class II only): Perform 150+0/-10°C for 1 hr and then set for 24±2 hrs at room temp. * Measurement to be made after keeping at room temp. for 24±2 hrs.	* No remarkable damage. * Cap change: NP0: within ±2.5% or 0.25pF whichever is larger X7R, X7E, X6S, X5R: within ±7.5% Y5V: within ±20% * Q/D.F., I.R. and dielectric strength: To meet initial requirements. * 25% max. leaching on each edge.																																																														
12.	Temperature Cycle	* Conduct the five cycles according to the temperatures and time. <table border="1"> <thead> <tr> <th>Step</th> <th>Temp. (°C)</th> <th>Time (min.)</th> </tr> </thead> <tbody> <tr> <td>1</td> <td>Min. operating temp. +0/-3</td> <td>30±3</td> </tr> <tr> <td>2</td> <td>Room temp.</td> <td>2~3</td> </tr> <tr> <td>3</td> <td>Max. operating temp. +3/-0</td> <td>30±3</td> </tr> <tr> <td>4</td> <td>Room temp.</td> <td>2~3</td> </tr> </tbody> </table> * Before initial measurement (Class II only): Perform 150+0/-10°C for 1 hr and then set for 24±2 hrs at room temp. * Measurement to be made after keeping at room temp. for 24±2 hrs.	Step	Temp. (°C)	Time (min.)	1	Min. operating temp. +0/-3	30±3	2	Room temp.	2~3	3	Max. operating temp. +3/-0	30±3	4	Room temp.	2~3	* No remarkable damage. * Cap change: NP0: within ±2.5% or 0.25pF whichever is larger X7R, X7E, X6S, X5R: within ±7.5% Y5V: within ±20% * Q/D.F., I.R. and dielectric strength: To meet initial requirements.																																															
Step	Temp. (°C)	Time (min.)																																																															
1	Min. operating temp. +0/-3	30±3																																																															
2	Room temp.	2~3																																																															
3	Max. operating temp. +3/-0	30±3																																																															
4	Room temp.	2~3																																																															
13.	Humidity (Damp Heat) Steady State	* Test temp.: 40±2°C * Humidity: 90~95% RH * Test time: 500+24/-0hrs. *Before initial measurement (Class II only): Perform 150+0/-10°C for 1 hr and then set for 24±2 hrs at room temp. * Measurement to be made after keeping at room temp. for 24±2 hrs.	* No remarkable damage. * Cap change: NP0: within ±5% or 0.5pF whichever is larger X7R, X7E, X6S, X5R: ≥10V**, within ±12.5%; 6.3V within ±25%; TT series, within ±25% **10V:0603±4.7μF;0402±1μF;0201±0.1μF, within ±25%; Y5V: ≥10V, within ±30%; 6.3V, within +30/-40% * Q/D.F. value: NP0: More than 30pF Q≥350, 10pF<C≤30pF, Q≥275+2.5C, Less than 10pF Q≥200+10C X7R, X6S, X5R: <table border="1"> <thead> <tr> <th>Rated vol.</th> <th>D.F. ≤</th> <th>Exception of D.F. ≤</th> </tr> </thead> <tbody> <tr> <td>≥100V</td> <td>≤3%</td> <td>≤6% 1206±0.47μF ≤7.5% 0805±0.1μF, 0603±0.068μF; 1206&gt;1μF; TT series</td> </tr> <tr> <td>≥50V</td> <td>≤3%</td> <td>≤6% 0201(50V);0603±0.047μF; 0805±0.18μF; 1206±0.47μF ≤10% 1210±4.7μF ≤20% 0402±0.1μF; 0603±0.1μF; 0603±1μF; 0805±1μF; 1206±2.2μF; 1210±10μF; TT series</td> </tr> <tr> <td>35V</td> <td>≤5%</td> <td>≤20% 0603±1μF; 0805±2.2μF; 1210±10μF</td> </tr> <tr> <td>25V</td> <td>≤5%</td> <td>≤10% 0201±0.01μF; 0805±1μF; 1210±10μF ≤14% 0603±0.33μF; 1206±4.7μF ≤15% 0402±0.10μF; 0603±0.47μF; 0805±2.2μF; 1206±6.8μF; 1210±22μF; TT series ≤20% 0402±1μF</td> </tr> <tr> <td>16V</td> <td>≤5%</td> <td>≤10% 0603±0.15μF; 0805±0.68μF; 1206±2.2μF; 1210±4.7μF ≤15% 0201±0.01μF; 0402±0.033μF; 0603±0.68μF; 0805±2.2μF; 1206±4.7μF; 1210±22μF; TT series</td> </tr> <tr> <td>10V</td> <td>≤7.5%</td> <td>≤15% 0201±0.012μF; 0402±0.33μF(0402/X7R±0.22μF); 0603±0.33μF; 0805±2.2μF; 1206±2.2μF; 1210±22μF ≤20% 0201±0.1μF ;0402±1μF; TT series</td> </tr> <tr> <td>6.3V</td> <td>≤15%</td> <td>≤30% 0201±0.1μF; 0402±1μF; 0603±10μF; 0805±4.7μF; 1206±4.7μF; 1210±100μF; TT series</td> </tr> <tr> <td>4V</td> <td>≤20%</td> <td>---</td> </tr> </tbody> </table> X7R/X7E, LD series : DF≤3% Y5V: <table border="1"> <thead> <tr> <th>Rated vol.</th> <th>D.F. ≤</th> <th>Exception of D.F. ≤</th> </tr> </thead> <tbody> <tr> <td>≥50V</td> <td>≤7.5%</td> <td>≤10% 0603±0.1μF; 0805±0.47μF; 1206±4.7μF</td> </tr> <tr> <td>35V</td> <td>≤10%</td> <td>---</td> </tr> <tr> <td>25V</td> <td>≤7.5%</td> <td>≤10% 0402±0.047μF; 0603±0.1μF; 0805±0.33μF; 1206±1μF; 1210±4.7μF ≤15% 0402±0.068μF; 0603±0.47μF; 1206±4.7μF; 1210±22μF; TT series &amp; Cap≥1μF ≤12.5% 0402±0.068μF; 0603±0.68μF</td> </tr> <tr> <td>16V (C&lt;1.0μF)</td> <td>≤10%</td> <td>≤20% 0402±0.22μF</td> </tr> <tr> <td>16V (C≥1.0μF)</td> <td>≤12.5%</td> <td>≤20% 0603±2.2μF; 0805±3.3μF; 1206±10μF; 1210±22μF; 1812±47μF; TT series &amp; Cap≥1μF</td> </tr> <tr> <td>10V</td> <td>≤20%</td> <td>≤30% 0402±0.47μF</td> </tr> <tr> <td>6.3V</td> <td>≤30%</td> <td>---</td> </tr> </tbody> </table> *I.R.: ≥10V, 1GΩ or 50 Ω-F whichever is smaller. Class II (X7R, X7E, X6S, X5R, Y5V) <table border="1"> <thead> <tr> <th>Rated voltage</th> <th>Insulation Resistance</th> </tr> </thead> <tbody> <tr> <td>100V: X7R</td> <td rowspan="6">1GΩ or RxC≥10 Ω-F whichever is smaller.</td> </tr> <tr> <td>50V:0402±0.1μF;0603±1μF;0805±1μF;1206±4.7μF;1210±4.7μF</td> </tr> <tr> <td>35V:0603±1μF;0805±2.2μF;1210±10μF</td> </tr> <tr> <td>25V:0201±0.1μF; 0402±0.22μF; 0603±2.2μF; 0805±2.2μF; 1206±10μF; 1210±10μF</td> </tr> <tr> <td>16V:0201±0.1μF;0402±0.22μF;0603±1μF;0805±2.2μF;1206±10μF;1210±47μF</td> </tr> <tr> <td>10V:0201±47nF;0402±0.47μF;0603±0.47μF; 0805±2.2μF; 1206±4.7μF;1210±47μF</td> </tr> <tr> <td>6.3V : 4V ; TT series</td> <td></td> </tr> </tbody> </table>	Rated vol.	D.F. ≤	Exception of D.F. ≤	≥100V	≤3%	≤6% 1206±0.47μF ≤7.5% 0805±0.1μF, 0603±0.068μF; 1206>1μF; TT series	≥50V	≤3%	≤6% 0201(50V);0603±0.047μF; 0805±0.18μF; 1206±0.47μF ≤10% 1210±4.7μF ≤20% 0402±0.1μF; 0603±0.1μF; 0603±1μF; 0805±1μF; 1206±2.2μF; 1210±10μF; TT series	35V	≤5%	≤20% 0603±1μF; 0805±2.2μF; 1210±10μF	25V	≤5%	≤10% 0201±0.01μF; 0805±1μF; 1210±10μF ≤14% 0603±0.33μF; 1206±4.7μF ≤15% 0402±0.10μF; 0603±0.47μF; 0805±2.2μF; 1206±6.8μF; 1210±22μF; TT series ≤20% 0402±1μF	16V	≤5%	≤10% 0603±0.15μF; 0805±0.68μF; 1206±2.2μF; 1210±4.7μF ≤15% 0201±0.01μF; 0402±0.033μF; 0603±0.68μF; 0805±2.2μF; 1206±4.7μF; 1210±22μF; TT series	10V	≤7.5%	≤15% 0201±0.012μF; 0402±0.33μF(0402/X7R±0.22μF); 0603±0.33μF; 0805±2.2μF; 1206±2.2μF; 1210±22μF ≤20% 0201±0.1μF ;0402±1μF; TT series	6.3V	≤15%	≤30% 0201±0.1μF; 0402±1μF; 0603±10μF; 0805±4.7μF; 1206±4.7μF; 1210±100μF; TT series	4V	≤20%	---	Rated vol.	D.F. ≤	Exception of D.F. ≤	≥50V	≤7.5%	≤10% 0603±0.1μF; 0805±0.47μF; 1206±4.7μF	35V	≤10%	---	25V	≤7.5%	≤10% 0402±0.047μF; 0603±0.1μF; 0805±0.33μF; 1206±1μF; 1210±4.7μF ≤15% 0402±0.068μF; 0603±0.47μF; 1206±4.7μF; 1210±22μF; TT series & Cap≥1μF ≤12.5% 0402±0.068μF; 0603±0.68μF	16V (C<1.0μF)	≤10%	≤20% 0402±0.22μF	16V (C≥1.0μF)	≤12.5%	≤20% 0603±2.2μF; 0805±3.3μF; 1206±10μF; 1210±22μF; 1812±47μF; TT series & Cap≥1μF	10V	≤20%	≤30% 0402±0.47μF	6.3V	≤30%	---	Rated voltage	Insulation Resistance	100V: X7R	1GΩ or RxC≥10 Ω-F whichever is smaller.	50V:0402±0.1μF;0603±1μF;0805±1μF;1206±4.7μF;1210±4.7μF	35V:0603±1μF;0805±2.2μF;1210±10μF	25V:0201±0.1μF; 0402±0.22μF; 0603±2.2μF; 0805±2.2μF; 1206±10μF; 1210±10μF	16V:0201±0.1μF;0402±0.22μF;0603±1μF;0805±2.2μF;1206±10μF;1210±47μF	10V:0201±47nF;0402±0.47μF;0603±0.47μF; 0805±2.2μF; 1206±4.7μF;1210±47μF	6.3V : 4V ; TT series	
Rated vol.	D.F. ≤	Exception of D.F. ≤																																																															
≥100V	≤3%	≤6% 1206±0.47μF ≤7.5% 0805±0.1μF, 0603±0.068μF; 1206>1μF; TT series																																																															
≥50V	≤3%	≤6% 0201(50V);0603±0.047μF; 0805±0.18μF; 1206±0.47μF ≤10% 1210±4.7μF ≤20% 0402±0.1μF; 0603±0.1μF; 0603±1μF; 0805±1μF; 1206±2.2μF; 1210±10μF; TT series																																																															
35V	≤5%	≤20% 0603±1μF; 0805±2.2μF; 1210±10μF																																																															
25V	≤5%	≤10% 0201±0.01μF; 0805±1μF; 1210±10μF ≤14% 0603±0.33μF; 1206±4.7μF ≤15% 0402±0.10μF; 0603±0.47μF; 0805±2.2μF; 1206±6.8μF; 1210±22μF; TT series ≤20% 0402±1μF																																																															
16V	≤5%	≤10% 0603±0.15μF; 0805±0.68μF; 1206±2.2μF; 1210±4.7μF ≤15% 0201±0.01μF; 0402±0.033μF; 0603±0.68μF; 0805±2.2μF; 1206±4.7μF; 1210±22μF; TT series																																																															
10V	≤7.5%	≤15% 0201±0.012μF; 0402±0.33μF(0402/X7R±0.22μF); 0603±0.33μF; 0805±2.2μF; 1206±2.2μF; 1210±22μF ≤20% 0201±0.1μF ;0402±1μF; TT series																																																															
6.3V	≤15%	≤30% 0201±0.1μF; 0402±1μF; 0603±10μF; 0805±4.7μF; 1206±4.7μF; 1210±100μF; TT series																																																															
4V	≤20%	---																																																															
Rated vol.	D.F. ≤	Exception of D.F. ≤																																																															
≥50V	≤7.5%	≤10% 0603±0.1μF; 0805±0.47μF; 1206±4.7μF																																																															
35V	≤10%	---																																																															
25V	≤7.5%	≤10% 0402±0.047μF; 0603±0.1μF; 0805±0.33μF; 1206±1μF; 1210±4.7μF ≤15% 0402±0.068μF; 0603±0.47μF; 1206±4.7μF; 1210±22μF; TT series & Cap≥1μF ≤12.5% 0402±0.068μF; 0603±0.68μF																																																															
16V (C<1.0μF)	≤10%	≤20% 0402±0.22μF																																																															
16V (C≥1.0μF)	≤12.5%	≤20% 0603±2.2μF; 0805±3.3μF; 1206±10μF; 1210±22μF; 1812±47μF; TT series & Cap≥1μF																																																															
10V	≤20%	≤30% 0402±0.47μF																																																															
6.3V	≤30%	---																																																															
Rated voltage	Insulation Resistance																																																																
100V: X7R	1GΩ or RxC≥10 Ω-F whichever is smaller.																																																																
50V:0402±0.1μF;0603±1μF;0805±1μF;1206±4.7μF;1210±4.7μF																																																																	
35V:0603±1μF;0805±2.2μF;1210±10μF																																																																	
25V:0201±0.1μF; 0402±0.22μF; 0603±2.2μF; 0805±2.2μF; 1206±10μF; 1210±10μF																																																																	
16V:0201±0.1μF;0402±0.22μF;0603±1μF;0805±2.2μF;1206±10μF;1210±47μF																																																																	
10V:0201±47nF;0402±0.47μF;0603±0.47μF; 0805±2.2μF; 1206±4.7μF;1210±47μF																																																																	
6.3V : 4V ; TT series																																																																	



No	Item	Test Condition	Requirements																																																																																																																																																			
14.	Humidity (Damp Heat) Load	<p>* Test temp.: 40±2°C                      * Humidity: 90-95%RH                      * Test time: 500+24/-0 hrs.                      * To apply voltage:                      Rated voltage (Max.500V)                      * Before initial measurement(Class II only): To apply test voltage for 1hr at 40°C and then set for 24±2 hrs at room temp.                      * Measurement to be made after keeping at room temp. for 24±2 hrs.</p>	<p>* No remarkable damage.                      Cap change: NP0: ±7.5% or 0.75pF whichever is larger.                      X7R, X7E, X6S, X5R: ±10V** within ±12.5%; 6.3V within ±25%; TT series, within ±25%                      ** 10V:0603±4.7µF;0402±1µF;0201±0.1µF, within ±25%;                      Y5V: ±10V, within ±30%; 6.3V, within ±30/-40%                      Q/D.F. value: NP0: C≥30pF, Q≥200; C&lt;30pF, Q≥100+10/3C                      X7R, X6S, X5R:</p> <table border="1"> <thead> <tr> <th>Rated vol.</th> <th>D.F.s</th> <th>Exception of D.F.s</th> </tr> </thead> <tbody> <tr> <td>≥100V</td> <td>≤3%</td> <td>≤6% 1206±0.47µF ≤7.5% 0805±0.1µF; 0603±0.08µF; 1206±1µF; TT series</td> </tr> <tr> <td>≥50V</td> <td>≤3%</td> <td>≤6% 0201(50V);0603±0.047µF; 0805±0.18µF; 1206±0.47µF ≤10% 1210±4.7µF</td> </tr> <tr> <td>35V</td> <td>≤5%</td> <td>≤20% 0402±0.1µF;0603±1µF; 0805±1µF; 1206±2.2µF; 1210±10µF; TT series ≤10% 0201±0.01µF;0805±1µF; 1210±10µF ≤14% 0603±0.33µF; 1206±4.7µF</td> </tr> <tr> <td>25V</td> <td>≤5%</td> <td>≤15% 0402±0.10µF;0603±0.47µF;0805±2.2µF; 1206±6.8µF; 1210±22µF; TT series ≤20% 0402±1µF</td> </tr> <tr> <td>16V</td> <td>≤5%</td> <td>≤10% 0603±0.15µF;0805±0.68µF; 1206±2.2µF; 1210±4.7µF ≤15% 0201±0.01µF;0402±0.03µF;0603±0.68µF;0805±2.2µF; 1206±4.7µF; 1210±22µF; TT series</td> </tr> <tr> <td>10V</td> <td>≤7.5%</td> <td>≤15% 0201±0.012µF; 0402±0.33µF; 0603±0.33µF; 0805±2.2µF; 1206±2.2µF; 1210±22µF ≤20% 0201±0.1µF; 0402±1µF; TT series</td> </tr> <tr> <td>6.3V</td> <td>≤15%</td> <td>≤30% 0201±0.1µF;0402±1µF;0603±10µF; 0805±4.7µF; 1206±47µF; 1210±100µF; TT series</td> </tr> <tr> <td>4V</td> <td>≤20%</td> <td>---</td> </tr> </tbody> </table> <p>X7R/X7E, LD series : DF≤3%                      Y5V:</p> <table border="1"> <thead> <tr> <th>Rated vol.</th> <th>D.F.s</th> <th>Exception of D.F.s</th> </tr> </thead> <tbody> <tr> <td>≥50V</td> <td>≤7.5%</td> <td>≤10% 0603±0.1µF; 0805±0.47µF; 1206±4.7µF; TT series &amp; Cap±1µF</td> </tr> <tr> <td>35V</td> <td>≤10%</td> <td>---</td> </tr> <tr> <td>25V</td> <td>≤7.5%</td> <td>≤10% 0402±0.047µF;0603±0.1µF;0805±0.33µF; 1206±1µF; 1210±4.7µF ≤15% 0402±0.068µF;0603±0.47µF;1206±4.7µF;1210±22µF; TT series &amp; Cap±1µF</td> </tr> <tr> <td>16V (C&lt;1.0µF)</td> <td>≤10%</td> <td>≤12.5% 0402±0.068µF; 0603±0.68µF ≤20% 0402±0.22µF</td> </tr> <tr> <td>10V (C≥1.0µF)</td> <td>≤12.5%</td> <td>≤20% 0603±2.2µF;0805±3.3µF;1206±10µF;1210±22µF;1612±47µF; TT series &amp; Cap±1µF</td> </tr> <tr> <td>10V</td> <td>≤20%</td> <td>≤30% 0402±0.47µF</td> </tr> <tr> <td>6.3V</td> <td>≤30%</td> <td>---</td> </tr> </tbody> </table> <p>*I.R.: ≥10V, 500MΩ or 25 Ω-F whichever is smaller.                      Class II (X7R, X7E, X6S, X5R, Y5V)</p> <table border="1"> <thead> <tr> <th>Rated voltage</th> <th>Insulation Resistance</th> </tr> </thead> <tbody> <tr> <td>100V: X7R</td> <td rowspan="7">500MΩ or RxC±5 Ω-F whichever is smaller.</td> </tr> <tr> <td>50V 0402±0.1µF;0603±1µF;0805±1µF;1206±4.7µF;1210±4.7µF</td> </tr> <tr> <td>35V 0603±1µF;0805±2.2µF;1210±10µF</td> </tr> <tr> <td>25V 0201±0.1µF; 0402±0.22µF; 0603±2.2µF;0805±2.2µF; 1206±10µF;1210±10µF</td> </tr> <tr> <td>16V 0201±0.1µF;0402±0.22µF; 0603±1µF;0805±2.2µF; 1206±10µF;1210±47µF</td> </tr> <tr> <td>10V 0201±47nF; 0402±0.47µF;0603±0.47µF; .0805±2.2µF;1206±4.7µF;1210±47µF</td> </tr> <tr> <td>6.3V ; 4V ; TT series; All X6S items</td> </tr> </tbody> </table>	Rated vol.	D.F.s	Exception of D.F.s	≥100V	≤3%	≤6% 1206±0.47µF ≤7.5% 0805±0.1µF; 0603±0.08µF; 1206±1µF; TT series	≥50V	≤3%	≤6% 0201(50V);0603±0.047µF; 0805±0.18µF; 1206±0.47µF ≤10% 1210±4.7µF	35V	≤5%	≤20% 0402±0.1µF;0603±1µF; 0805±1µF; 1206±2.2µF; 1210±10µF; TT series ≤10% 0201±0.01µF;0805±1µF; 1210±10µF ≤14% 0603±0.33µF; 1206±4.7µF	25V	≤5%	≤15% 0402±0.10µF;0603±0.47µF;0805±2.2µF; 1206±6.8µF; 1210±22µF; TT series ≤20% 0402±1µF	16V	≤5%	≤10% 0603±0.15µF;0805±0.68µF; 1206±2.2µF; 1210±4.7µF ≤15% 0201±0.01µF;0402±0.03µF;0603±0.68µF;0805±2.2µF; 1206±4.7µF; 1210±22µF; TT series	10V	≤7.5%	≤15% 0201±0.012µF; 0402±0.33µF; 0603±0.33µF; 0805±2.2µF; 1206±2.2µF; 1210±22µF ≤20% 0201±0.1µF; 0402±1µF; TT series	6.3V	≤15%	≤30% 0201±0.1µF;0402±1µF;0603±10µF; 0805±4.7µF; 1206±47µF; 1210±100µF; TT series	4V	≤20%	---	Rated vol.	D.F.s	Exception of D.F.s	≥50V	≤7.5%	≤10% 0603±0.1µF; 0805±0.47µF; 1206±4.7µF; TT series & Cap±1µF	35V	≤10%	---	25V	≤7.5%	≤10% 0402±0.047µF;0603±0.1µF;0805±0.33µF; 1206±1µF; 1210±4.7µF ≤15% 0402±0.068µF;0603±0.47µF;1206±4.7µF;1210±22µF; TT series & Cap±1µF	16V (C<1.0µF)	≤10%	≤12.5% 0402±0.068µF; 0603±0.68µF ≤20% 0402±0.22µF	10V (C≥1.0µF)	≤12.5%	≤20% 0603±2.2µF;0805±3.3µF;1206±10µF;1210±22µF;1612±47µF; TT series & Cap±1µF	10V	≤20%	≤30% 0402±0.47µF	6.3V	≤30%	---	Rated voltage	Insulation Resistance	100V: X7R	500MΩ or RxC±5 Ω-F whichever is smaller.	50V 0402±0.1µF;0603±1µF;0805±1µF;1206±4.7µF;1210±4.7µF	35V 0603±1µF;0805±2.2µF;1210±10µF	25V 0201±0.1µF; 0402±0.22µF; 0603±2.2µF;0805±2.2µF; 1206±10µF;1210±10µF	16V 0201±0.1µF;0402±0.22µF; 0603±1µF;0805±2.2µF; 1206±10µF;1210±47µF	10V 0201±47nF; 0402±0.47µF;0603±0.47µF; .0805±2.2µF;1206±4.7µF;1210±47µF	6.3V ; 4V ; TT series; All X6S items																																																																																						
Rated vol.	D.F.s	Exception of D.F.s																																																																																																																																																				
≥100V	≤3%	≤6% 1206±0.47µF ≤7.5% 0805±0.1µF; 0603±0.08µF; 1206±1µF; TT series																																																																																																																																																				
≥50V	≤3%	≤6% 0201(50V);0603±0.047µF; 0805±0.18µF; 1206±0.47µF ≤10% 1210±4.7µF																																																																																																																																																				
35V	≤5%	≤20% 0402±0.1µF;0603±1µF; 0805±1µF; 1206±2.2µF; 1210±10µF; TT series ≤10% 0201±0.01µF;0805±1µF; 1210±10µF ≤14% 0603±0.33µF; 1206±4.7µF																																																																																																																																																				
25V	≤5%	≤15% 0402±0.10µF;0603±0.47µF;0805±2.2µF; 1206±6.8µF; 1210±22µF; TT series ≤20% 0402±1µF																																																																																																																																																				
16V	≤5%	≤10% 0603±0.15µF;0805±0.68µF; 1206±2.2µF; 1210±4.7µF ≤15% 0201±0.01µF;0402±0.03µF;0603±0.68µF;0805±2.2µF; 1206±4.7µF; 1210±22µF; TT series																																																																																																																																																				
10V	≤7.5%	≤15% 0201±0.012µF; 0402±0.33µF; 0603±0.33µF; 0805±2.2µF; 1206±2.2µF; 1210±22µF ≤20% 0201±0.1µF; 0402±1µF; TT series																																																																																																																																																				
6.3V	≤15%	≤30% 0201±0.1µF;0402±1µF;0603±10µF; 0805±4.7µF; 1206±47µF; 1210±100µF; TT series																																																																																																																																																				
4V	≤20%	---																																																																																																																																																				
Rated vol.	D.F.s	Exception of D.F.s																																																																																																																																																				
≥50V	≤7.5%	≤10% 0603±0.1µF; 0805±0.47µF; 1206±4.7µF; TT series & Cap±1µF																																																																																																																																																				
35V	≤10%	---																																																																																																																																																				
25V	≤7.5%	≤10% 0402±0.047µF;0603±0.1µF;0805±0.33µF; 1206±1µF; 1210±4.7µF ≤15% 0402±0.068µF;0603±0.47µF;1206±4.7µF;1210±22µF; TT series & Cap±1µF																																																																																																																																																				
16V (C<1.0µF)	≤10%	≤12.5% 0402±0.068µF; 0603±0.68µF ≤20% 0402±0.22µF																																																																																																																																																				
10V (C≥1.0µF)	≤12.5%	≤20% 0603±2.2µF;0805±3.3µF;1206±10µF;1210±22µF;1612±47µF; TT series & Cap±1µF																																																																																																																																																				
10V	≤20%	≤30% 0402±0.47µF																																																																																																																																																				
6.3V	≤30%	---																																																																																																																																																				
Rated voltage	Insulation Resistance																																																																																																																																																					
100V: X7R	500MΩ or RxC±5 Ω-F whichever is smaller.																																																																																																																																																					
50V 0402±0.1µF;0603±1µF;0805±1µF;1206±4.7µF;1210±4.7µF																																																																																																																																																						
35V 0603±1µF;0805±2.2µF;1210±10µF																																																																																																																																																						
25V 0201±0.1µF; 0402±0.22µF; 0603±2.2µF;0805±2.2µF; 1206±10µF;1210±10µF																																																																																																																																																						
16V 0201±0.1µF;0402±0.22µF; 0603±1µF;0805±2.2µF; 1206±10µF;1210±47µF																																																																																																																																																						
10V 0201±47nF; 0402±0.47µF;0603±0.47µF; .0805±2.2µF;1206±4.7µF;1210±47µF																																																																																																																																																						
6.3V ; 4V ; TT series; All X6S items																																																																																																																																																						
15.	High Temperature Load (Endurance)	<p>*Test temp.:                      NP0, X7R/X7E: 125±3°C                      X6S: 105±3°C                      X5R, Y5V: 85±3°C                      *Test time: 1000+24/-0 hrs.                      *To apply voltage:                      (1) 6.3V or C≥10µF or TT series:                      150% of rated voltage.                      (2) 10V≤Ur&lt;500V                      200% of rated voltage.                      (3) 500V: 150% of rated voltage.                      (4) Ur≥630V:                      120% of rated voltage.                      (5) 100% of rated voltage for below range.</p> <table border="1"> <thead> <tr> <th>Size</th> <th>Dielectric</th> <th>Rated voltage</th> <th>Capacitance range</th> </tr> </thead> <tbody> <tr> <td>0201</td> <td rowspan="10">X7R/ X6S/ X5R</td> <td>≤10V</td> <td>C≥0.1µF</td> </tr> <tr> <td>0402</td> <td>6.3V,10V,25V</td> <td>C≥1.0µF</td> </tr> <tr> <td rowspan="3">0603</td> <td>4V</td> <td>C≥2µF</td> </tr> <tr> <td>6.3V,10V</td> <td>C≥4.7µF</td> </tr> <tr> <td>25V,35V</td> <td>C≥1.0µF</td> </tr> <tr> <td rowspan="2">0805</td> <td>4V</td> <td>C≥4.7µF</td> </tr> <tr> <td>6.3V</td> <td>C≥2µF</td> </tr> <tr> <td rowspan="2">1206</td> <td>10V-50V</td> <td>C≥10µF</td> </tr> <tr> <td>6.3V</td> <td>C≥47µF</td> </tr> <tr> <td>1210</td> <td>NP0</td> <td>3000V</td> <td>C≥1.5pF</td> </tr> <tr> <td>TT18</td> <td>X5R/X7R/X6S</td> <td>16V</td> <td>C≥47µF</td> </tr> <tr> <td>TT21</td> <td>Y5V</td> <td>6.3V,10V</td> <td>C≥2.2µF</td> </tr> <tr> <td>TT21</td> <td>Y5V</td> <td>6.3V</td> <td>C≥10µF</td> </tr> <tr> <td>TT31</td> <td>Y5V</td> <td>6.3V</td> <td>C≥22µF</td> </tr> </tbody> </table> <p>**1WV items must follow de-rating conditions                      (6)150% of rated voltage for below range.</p> <table border="1"> <thead> <tr> <th>Size</th> <th>Dielectric</th> <th>Rated voltage</th> <th>Capacitance</th> </tr> </thead> <tbody> <tr> <td>0201</td> <td>X5R/X7R/X6S</td> <td>16V/25V</td> <td>C≥0.1µF</td> </tr> <tr> <td rowspan="2">0402</td> <td rowspan="2">X5R/X7R/X6S</td> <td>50V</td> <td>C≥0.1µF</td> </tr> <tr> <td>10-25V</td> <td>C≥0.22µF</td> </tr> <tr> <td rowspan="2">0603</td> <td rowspan="2">X7R</td> <td>16V</td> <td>C≥0.47µF</td> </tr> <tr> <td>50V</td> <td>C≥0.1µF</td> </tr> <tr> <td rowspan="2">0805</td> <td rowspan="2">X5R/X7R/</td> <td>10-50V</td> <td>C≥1.0µF</td> </tr> <tr> <td>Y5V</td> <td>C≥2.2µF</td> </tr> <tr> <td rowspan="2">1210</td> <td rowspan="2">X5R/X7R/X6S</td> <td>10-50V</td> <td>C≥4.7µF</td> </tr> <tr> <td>50V</td> <td>C≥2.2µF</td> </tr> <tr> <td rowspan="2">2220</td> <td rowspan="2">X5R/X7R</td> <td>100V</td> <td>C≥0.47µF</td> </tr> <tr> <td>Y5V</td> <td>C≥4.7µF</td> </tr> </tbody> </table> <p>*Before initial measurement (Class II only): To apply test voltage for 1hr at test temp. and then set for 24±2 hrs at room temp.                      *Measurement to be made after keeping at room temp. for 24±2 hrs</p>	Size	Dielectric	Rated voltage	Capacitance range	0201	X7R/ X6S/ X5R	≤10V	C≥0.1µF	0402	6.3V,10V,25V	C≥1.0µF	0603	4V	C≥2µF	6.3V,10V	C≥4.7µF	25V,35V	C≥1.0µF	0805	4V	C≥4.7µF	6.3V	C≥2µF	1206	10V-50V	C≥10µF	6.3V	C≥47µF	1210	NP0	3000V	C≥1.5pF	TT18	X5R/X7R/X6S	16V	C≥47µF	TT21	Y5V	6.3V,10V	C≥2.2µF	TT21	Y5V	6.3V	C≥10µF	TT31	Y5V	6.3V	C≥22µF	Size	Dielectric	Rated voltage	Capacitance	0201	X5R/X7R/X6S	16V/25V	C≥0.1µF	0402	X5R/X7R/X6S	50V	C≥0.1µF	10-25V	C≥0.22µF	0603	X7R	16V	C≥0.47µF	50V	C≥0.1µF	0805	X5R/X7R/	10-50V	C≥1.0µF	Y5V	C≥2.2µF	1210	X5R/X7R/X6S	10-50V	C≥4.7µF	50V	C≥2.2µF	2220	X5R/X7R	100V	C≥0.47µF	Y5V	C≥4.7µF	<p>* No remarkable damage. Cap change: NP0: ±3.0% or ±0.3pF whichever is larger                      X7R, X7E, X6S, X5R: ±10V** within ±12.5%; 6.3V within ±25%; TT series, within ±25%                      ** 10V:0603±4.7µF;0402±1µF;0201±0.1µF, within ±25%;                      Y5V: ±10V, within ±30%; 6.3V, within ±30/-40%                      Q/D.F. value: NP0: More than 30pF, Q≥350; 10pF≤C&lt;30pF, Q≥275+2.5C; Less than 10pF, Q≥200+10C                      X7R, X6S, X5R:</p> <table border="1"> <thead> <tr> <th>Rated vol.</th> <th>D.F.s</th> <th>Exception of D.F.s</th> </tr> </thead> <tbody> <tr> <td>≥100V</td> <td>≤3%</td> <td>≤6% 1206±0.47µF ≤7.5% 0805±0.1µF; 0603±0.08µF; 1206±1µF; TT series</td> </tr> <tr> <td>≥50V</td> <td>≤3%</td> <td>≤6% 0201(50V);0603±0.047µF; 0805±0.18µF; 1206±0.47µF ≤10% 1210±4.7µF</td> </tr> <tr> <td>35V</td> <td>≤5%</td> <td>≤20% 0402±0.1µF;0603±1µF; 0805±1µF; 1206±2.2µF; 1210±10µF; TT series ≤10% 0603±1µF; 0805±2.2µF; 1210±10µF ≤10% 0201±0.01µF;0805±1µF; 1210±10µF ≤14% 0603±0.33µF; 1206±4.7µF</td> </tr> <tr> <td>25V</td> <td>≤5%</td> <td>≤15% 0402±0.10µF;0603±0.47µF;0805±2.2µF; 1206±6.8µF; 1210±22µF; TT series ≤20% 0402±1µF</td> </tr> <tr> <td>16V</td> <td>≤5%</td> <td>≤10% 0603±0.15µF;0805±0.68µF; 1206±2.2µF; 1210±4.7µF ≤15% 0201±0.01µF;0402±0.03µF;0603±0.68µF;0805±2.2µF; 1206±4.7µF; 1210±22µF; TT series</td> </tr> <tr> <td>10V</td> <td>≤7.5%</td> <td>≤15% 0201±0.012µF; 0402±0.33µF;0603±0.33µF; 0805±2.2µF; 1206±2.2µF; 1210±22µF; ≤20% 0201±0.1µF; 0402±1µF; TT series</td> </tr> <tr> <td>6.3V</td> <td>≤15%</td> <td>≤30% 0201±0.1µF;0402±1µF;0603±10µF; 0805±4.7µF; 1206±47µF; 1210±100µF; TT series</td> </tr> <tr> <td>4V</td> <td>≤20%</td> <td>---</td> </tr> </tbody> </table> <p>X7R/X7E, LD series : DF≤3%                      Y5V:</p> <table border="1"> <thead> <tr> <th>Rated vol.</th> <th>D.F.s</th> <th>Exception of D.F.s</th> </tr> </thead> <tbody> <tr> <td>≥50V</td> <td>≤7.5%</td> <td>≤10% 0603±0.1µF; 0805±0.47µF; 1206±4.7µF; TT series &amp; Cap±1µF</td> </tr> <tr> <td>35V</td> <td>≤10%</td> <td>---</td> </tr> <tr> <td>25V</td> <td>≤7.5%</td> <td>≤10% 0402±0.047µF;0603±0.1µF;0805±0.33µF; 1206±1µF; 1210±4.7µF ≤15% 0402±0.068µF;0603±0.47µF;1206±4.7µF;1210±22µF; TT series &amp; Cap±1µF ≤12.5% 0402±0.068µF; 0603±0.68µF</td> </tr> <tr> <td>16V(C&lt;1.0µF)</td> <td>≤10%</td> <td>≤20% 0402±0.22µF</td> </tr> <tr> <td>10V(C≥1.0µF)</td> <td>≤12.5%</td> <td>≤20% 0603±2.2µF;0805±3.3µF;1206±10µF;1210±22µF;1612±47µF; TT series &amp; Cap±1µF</td> </tr> <tr> <td>10V</td> <td>≤20%</td> <td>≤30% 0402±0.47µF</td> </tr> <tr> <td>6.3V</td> <td>≤30%</td> <td>---</td> </tr> </tbody> </table> <p>*I.R.: ≥10V, 1GΩ or 50 Ω-F whichever is smaller.                      Class II (X7R, X7E, X6S, X5R, Y5V)</p> <table border="1"> <thead> <tr> <th>Rated voltage</th> <th>Insulation Resistance</th> </tr> </thead> <tbody> <tr> <td>100V: X7R</td> <td rowspan="7">1GΩ or RxC±10 Ω-F whichever is smaller.</td> </tr> <tr> <td>50V 0402±0.1µF;0603±1µF;0805±1µF;1206±4.7µF;1210±4.7µF</td> </tr> <tr> <td>35V 0603±1µF;0805±2.2µF;1210±10µF</td> </tr> <tr> <td>25V 0201±0.1µF; 0402±0.22µF; 0603±2.2µF;0805±2.2µF; 1206±10µF;1210±10µF</td> </tr> <tr> <td>16V 0201±0.1µF;0402±0.22µF; 0603±1µF;0805±2.2µF; 1206±10µF;1210±47µF</td> </tr> <tr> <td>10V 0201±47nF; 0402±0.47µF;0603±0.47µF;0805±2.2µF; 1206±4.7µF;1210±47µF</td> </tr> <tr> <td>6.3V ; 4V ; TT series; All X6S items</td> </tr> </tbody> </table>	Rated vol.	D.F.s	Exception of D.F.s	≥100V	≤3%	≤6% 1206±0.47µF ≤7.5% 0805±0.1µF; 0603±0.08µF; 1206±1µF; TT series	≥50V	≤3%	≤6% 0201(50V);0603±0.047µF; 0805±0.18µF; 1206±0.47µF ≤10% 1210±4.7µF	35V	≤5%	≤20% 0402±0.1µF;0603±1µF; 0805±1µF; 1206±2.2µF; 1210±10µF; TT series ≤10% 0603±1µF; 0805±2.2µF; 1210±10µF ≤10% 0201±0.01µF;0805±1µF; 1210±10µF ≤14% 0603±0.33µF; 1206±4.7µF	25V	≤5%	≤15% 0402±0.10µF;0603±0.47µF;0805±2.2µF; 1206±6.8µF; 1210±22µF; TT series ≤20% 0402±1µF	16V	≤5%	≤10% 0603±0.15µF;0805±0.68µF; 1206±2.2µF; 1210±4.7µF ≤15% 0201±0.01µF;0402±0.03µF;0603±0.68µF;0805±2.2µF; 1206±4.7µF; 1210±22µF; TT series	10V	≤7.5%	≤15% 0201±0.012µF; 0402±0.33µF;0603±0.33µF; 0805±2.2µF; 1206±2.2µF; 1210±22µF; ≤20% 0201±0.1µF; 0402±1µF; TT series	6.3V	≤15%	≤30% 0201±0.1µF;0402±1µF;0603±10µF; 0805±4.7µF; 1206±47µF; 1210±100µF; TT series	4V	≤20%	---	Rated vol.	D.F.s	Exception of D.F.s	≥50V	≤7.5%	≤10% 0603±0.1µF; 0805±0.47µF; 1206±4.7µF; TT series & Cap±1µF	35V	≤10%	---	25V	≤7.5%	≤10% 0402±0.047µF;0603±0.1µF;0805±0.33µF; 1206±1µF; 1210±4.7µF ≤15% 0402±0.068µF;0603±0.47µF;1206±4.7µF;1210±22µF; TT series & Cap±1µF ≤12.5% 0402±0.068µF; 0603±0.68µF	16V(C<1.0µF)	≤10%	≤20% 0402±0.22µF	10V(C≥1.0µF)	≤12.5%	≤20% 0603±2.2µF;0805±3.3µF;1206±10µF;1210±22µF;1612±47µF; TT series & Cap±1µF	10V	≤20%	≤30% 0402±0.47µF	6.3V	≤30%	---	Rated voltage	Insulation Resistance	100V: X7R	1GΩ or RxC±10 Ω-F whichever is smaller.	50V 0402±0.1µF;0603±1µF;0805±1µF;1206±4.7µF;1210±4.7µF	35V 0603±1µF;0805±2.2µF;1210±10µF	25V 0201±0.1µF; 0402±0.22µF; 0603±2.2µF;0805±2.2µF; 1206±10µF;1210±10µF	16V 0201±0.1µF;0402±0.22µF; 0603±1µF;0805±2.2µF; 1206±10µF;1210±47µF	10V 0201±47nF; 0402±0.47µF;0603±0.47µF;0805±2.2µF; 1206±4.7µF;1210±47µF	6.3V ; 4V ; TT series; All X6S items
Size	Dielectric	Rated voltage	Capacitance range																																																																																																																																																			
0201	X7R/ X6S/ X5R	≤10V	C≥0.1µF																																																																																																																																																			
0402		6.3V,10V,25V	C≥1.0µF																																																																																																																																																			
0603		4V	C≥2µF																																																																																																																																																			
		6.3V,10V	C≥4.7µF																																																																																																																																																			
		25V,35V	C≥1.0µF																																																																																																																																																			
0805		4V	C≥4.7µF																																																																																																																																																			
		6.3V	C≥2µF																																																																																																																																																			
1206		10V-50V	C≥10µF																																																																																																																																																			
		6.3V	C≥47µF																																																																																																																																																			
1210		NP0	3000V	C≥1.5pF																																																																																																																																																		
TT18	X5R/X7R/X6S	16V	C≥47µF																																																																																																																																																			
TT21	Y5V	6.3V,10V	C≥2.2µF																																																																																																																																																			
TT21	Y5V	6.3V	C≥10µF																																																																																																																																																			
TT31	Y5V	6.3V	C≥22µF																																																																																																																																																			
Size	Dielectric	Rated voltage	Capacitance																																																																																																																																																			
0201	X5R/X7R/X6S	16V/25V	C≥0.1µF																																																																																																																																																			
0402	X5R/X7R/X6S	50V	C≥0.1µF																																																																																																																																																			
		10-25V	C≥0.22µF																																																																																																																																																			
0603	X7R	16V	C≥0.47µF																																																																																																																																																			
		50V	C≥0.1µF																																																																																																																																																			
0805	X5R/X7R/	10-50V	C≥1.0µF																																																																																																																																																			
		Y5V	C≥2.2µF																																																																																																																																																			
1210	X5R/X7R/X6S	10-50V	C≥4.7µF																																																																																																																																																			
		50V	C≥2.2µF																																																																																																																																																			
2220	X5R/X7R	100V	C≥0.47µF																																																																																																																																																			
		Y5V	C≥4.7µF																																																																																																																																																			
Rated vol.	D.F.s	Exception of D.F.s																																																																																																																																																				
≥100V	≤3%	≤6% 1206±0.47µF ≤7.5% 0805±0.1µF; 0603±0.08µF; 1206±1µF; TT series																																																																																																																																																				
≥50V	≤3%	≤6% 0201(50V);0603±0.047µF; 0805±0.18µF; 1206±0.47µF ≤10% 1210±4.7µF																																																																																																																																																				
35V	≤5%	≤20% 0402±0.1µF;0603±1µF; 0805±1µF; 1206±2.2µF; 1210±10µF; TT series ≤10% 0603±1µF; 0805±2.2µF; 1210±10µF ≤10% 0201±0.01µF;0805±1µF; 1210±10µF ≤14% 0603±0.33µF; 1206±4.7µF																																																																																																																																																				
25V	≤5%	≤15% 0402±0.10µF;0603±0.47µF;0805±2.2µF; 1206±6.8µF; 1210±22µF; TT series ≤20% 0402±1µF																																																																																																																																																				
16V	≤5%	≤10% 0603±0.15µF;0805±0.68µF; 1206±2.2µF; 1210±4.7µF ≤15% 0201±0.01µF;0402±0.03µF;0603±0.68µF;0805±2.2µF; 1206±4.7µF; 1210±22µF; TT series																																																																																																																																																				
10V	≤7.5%	≤15% 0201±0.012µF; 0402±0.33µF;0603±0.33µF; 0805±2.2µF; 1206±2.2µF; 1210±22µF; ≤20% 0201±0.1µF; 0402±1µF; TT series																																																																																																																																																				
6.3V	≤15%	≤30% 0201±0.1µF;0402±1µF;0603±10µF; 0805±4.7µF; 1206±47µF; 1210±100µF; TT series																																																																																																																																																				
4V	≤20%	---																																																																																																																																																				
Rated vol.	D.F.s	Exception of D.F.s																																																																																																																																																				
≥50V	≤7.5%	≤10% 0603±0.1µF; 0805±0.47µF; 1206±4.7µF; TT series & Cap±1µF																																																																																																																																																				
35V	≤10%	---																																																																																																																																																				
25V	≤7.5%	≤10% 0402±0.047µF;0603±0.1µF;0805±0.33µF; 1206±1µF; 1210±4.7µF ≤15% 0402±0.068µF;0603±0.47µF;1206±4.7µF;1210±22µF; TT series & Cap±1µF ≤12.5% 0402±0.068µF; 0603±0.68µF																																																																																																																																																				
16V(C<1.0µF)	≤10%	≤20% 0402±0.22µF																																																																																																																																																				
10V(C≥1.0µF)	≤12.5%	≤20% 0603±2.2µF;0805±3.3µF;1206±10µF;1210±22µF;1612±47µF; TT series & Cap±1µF																																																																																																																																																				
10V	≤20%	≤30% 0402±0.47µF																																																																																																																																																				
6.3V	≤30%	---																																																																																																																																																				
Rated voltage	Insulation Resistance																																																																																																																																																					
100V: X7R	1GΩ or RxC±10 Ω-F whichever is smaller.																																																																																																																																																					
50V 0402±0.1µF;0603±1µF;0805±1µF;1206±4.7µF;1210±4.7µF																																																																																																																																																						
35V 0603±1µF;0805±2.2µF;1210±10µF																																																																																																																																																						
25V 0201±0.1µF; 0402±0.22µF; 0603±2.2µF;0805±2.2µF; 1206±10µF;1210±10µF																																																																																																																																																						
16V 0201±0.1µF;0402±0.22µF; 0603±1µF;0805±2.2µF; 1206±10µF;1210±47µF																																																																																																																																																						
10V 0201±47nF; 0402±0.47µF;0603±0.47µF;0805±2.2µF; 1206±4.7µF;1210±47µF																																																																																																																																																						
6.3V ; 4V ; TT series; All X6S items																																																																																																																																																						
16.	ESR	For RF Series only, refer to data sheet.	---																																																																																																																																																			

## Constructions

No.	Name	NP0	NPO/X7R/X6S/X5R/Y5V
①	Ceramic material	BaTiO3 based	
②	Inner electrode	AgPd alloy	Ni
③	Termination	Inner layer	Ag
		Middle layer	Ni
		Outer layer	Sn

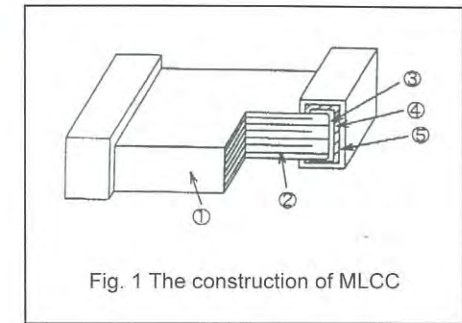

## Storage and handling conditions

- To store products at 5 to 40°C ambient temperature and 20 to 70% related humidity conditions.
- The product is recommended to be used within one year after shipment. Check solderability in case of shelf life extension is needed.

## Cautions:

- The corrosive gas reacts on the terminal electrodes of capacitors, and results in the poor solderability. Do not store the capacitors in the ambience of corrosive gas (e.g., hydrogen sulfide, sulfur dioxide, chlorine, ammonia gas etc.)
- In corrosive atmosphere, solderability might be degraded, and silver migration might occur to cause low reliability.
- Due to the dewing by rapid humidity change, or the photochemical change of the terminal electrode by direct sunlight, the solderability and electrical performance may deteriorate. Do not store capacitors under direct sunlight or dewing condition. To store products on the shelf and avoid exposure to moisture.

## Recommended soldering conditions

The lead-free termination MLCCs are not only to be used on SMT against lead-free solder paste, but also suitable against lead-containing solder paste. If the optimized solder joint is requested, increasing soldering time, temperature and concentration of N2 within oven are recommended.

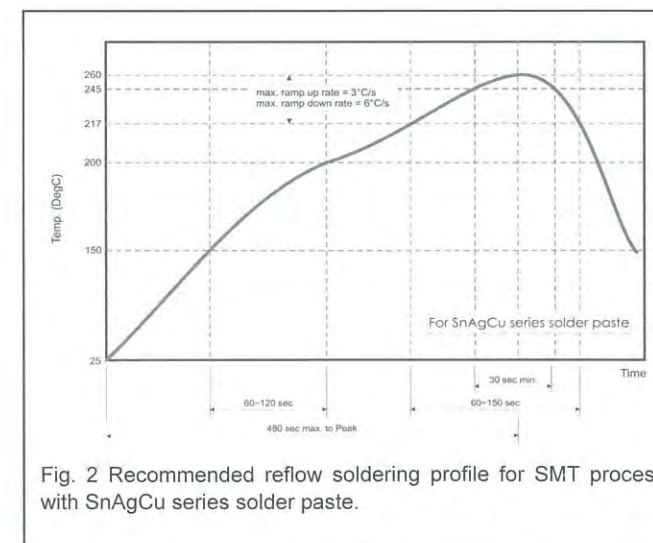

Fig. 2 Recommended reflow soldering profile for SMT process with SnAgCu series solder paste.

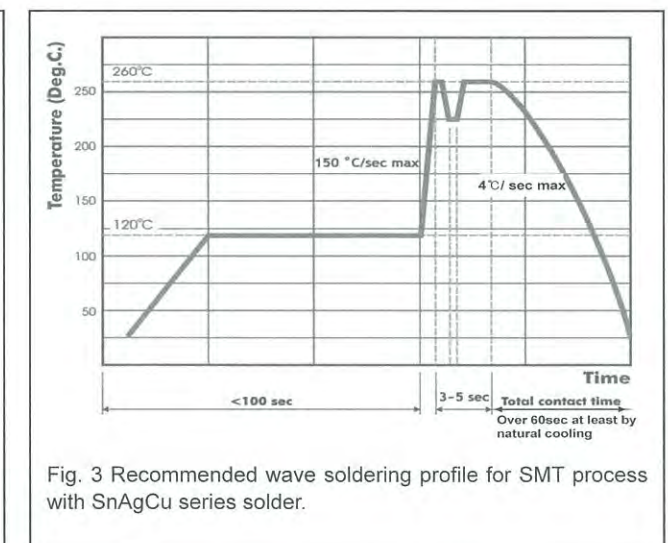

Fig. 3 Recommended wave soldering profile for SMT process with SnAgCu series solder.